

LIST OF FIGURES

MATTER

(Re-examined)

AN ALTERNATIVE CONCEPT
By NAINAN K. VARGHESE

UNIVERSAL MEDIUM

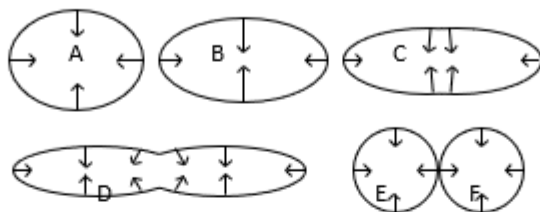

Figure 2.1

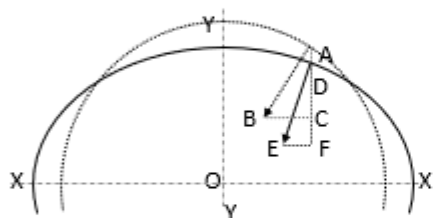

Figure 2.2



Figure 2.3

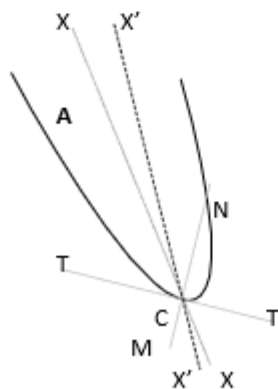

Figure 2.4

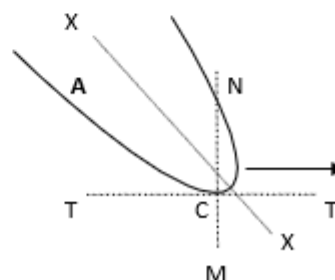

Figure 2.5

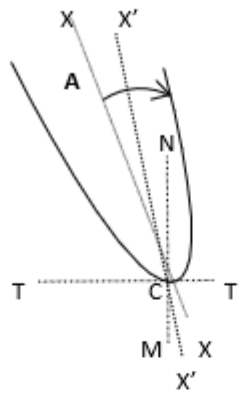

Figure 2.6

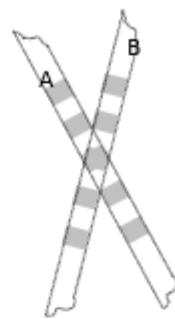

Figure 2.7

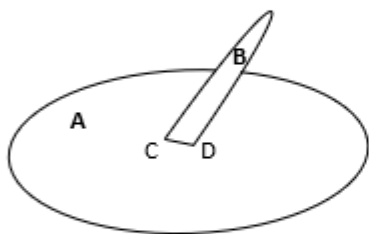

Figure 2.8

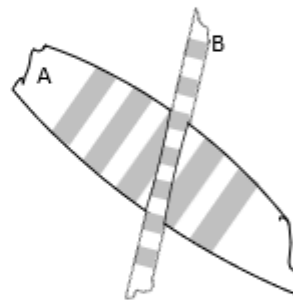

Figure 2.9

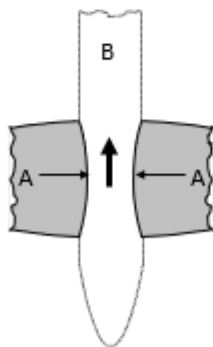

Figure 2.10

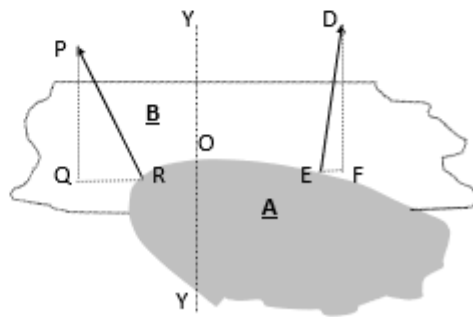

Figure 2.11

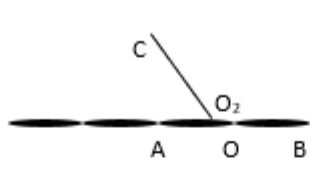

Figure 2.17

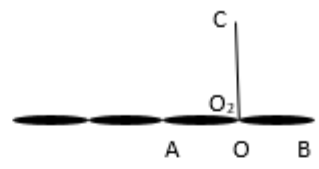

Figure 2.18

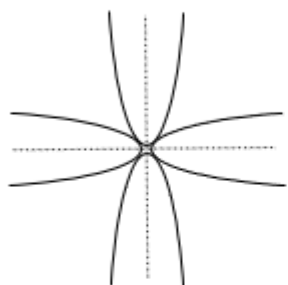

Figure 2.19

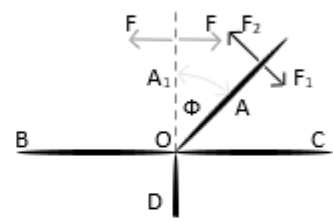

Figure 2.20

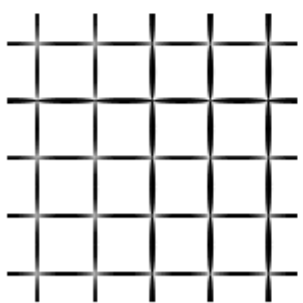

Figure 2.21

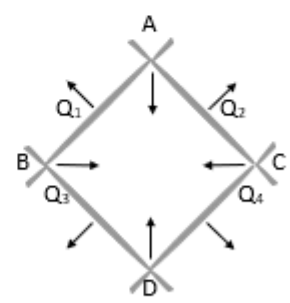

Figure 2.22

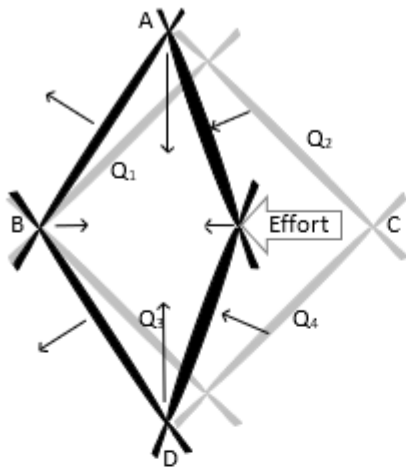

Figure 2.23

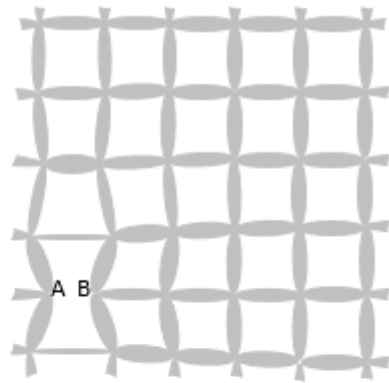

Figure 2.24

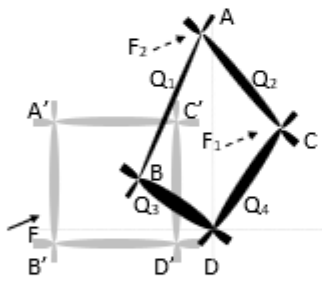

Figure 2.25

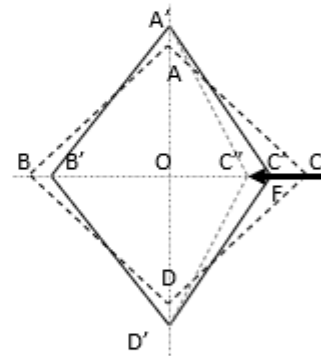

Figure 2.26

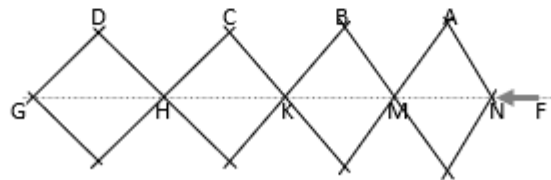

Figure 2.27

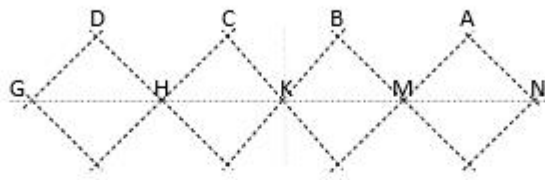

Figure 2.28

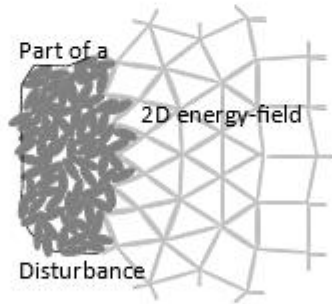

Figure 2.29

GRAVITATION

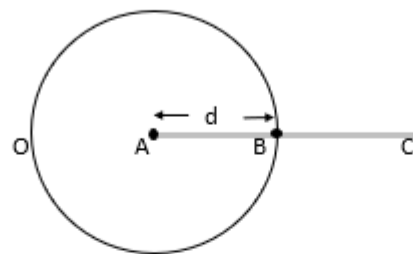

Figure 3.1

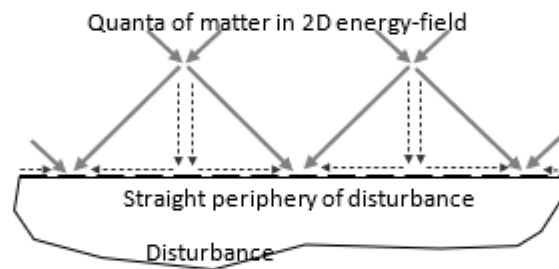

Figure 3.2

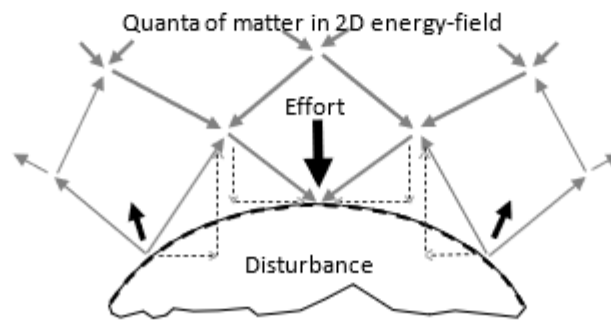

Figure 3.3

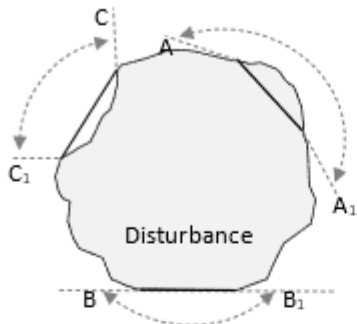

Figure 3.4

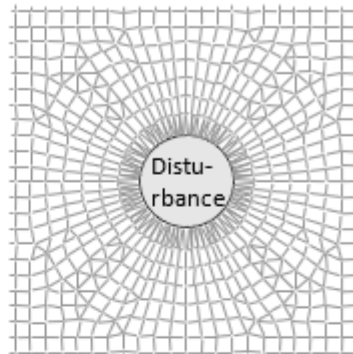

Figure 3.5

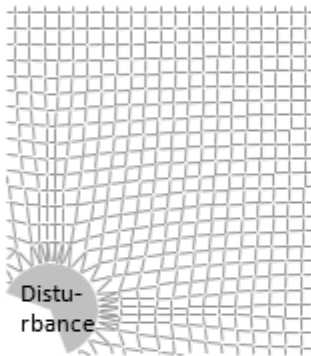

Figure 3.6

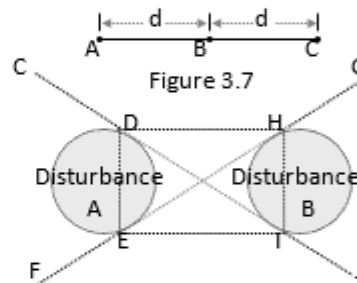

Figure 3.7

Figure 3.8

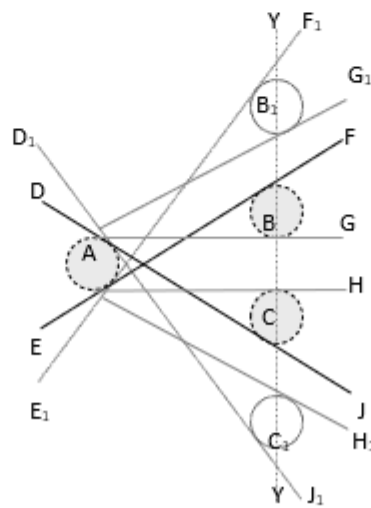

Figure 3.9

PHOTON

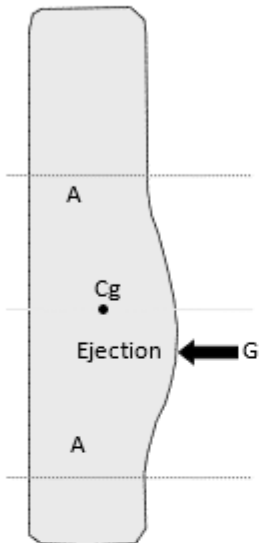
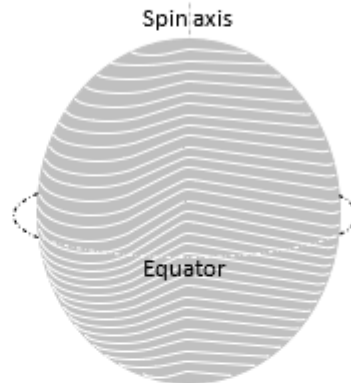

Figure 4.1



3D matter-core of photon
Figure 4.2

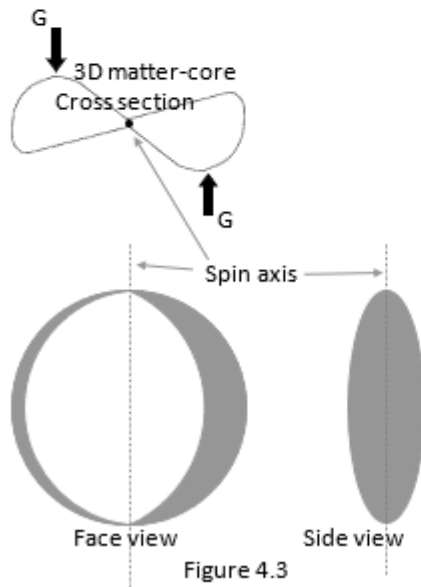

Figure 4.3

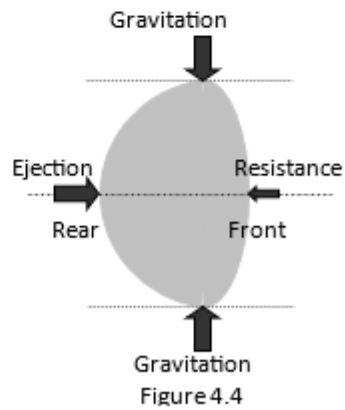

Figure 4.4

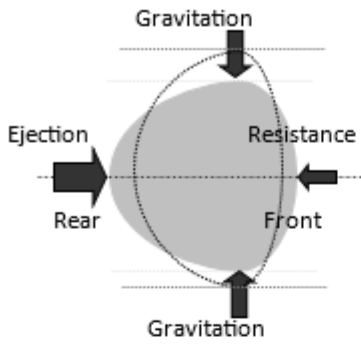

Figure 4.5

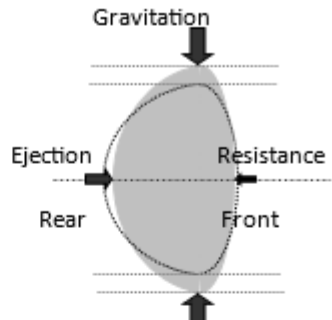

Figure 4.6

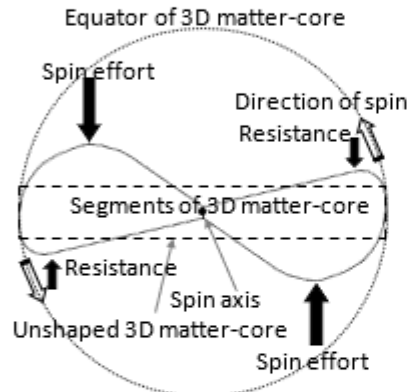

Figure 4.7

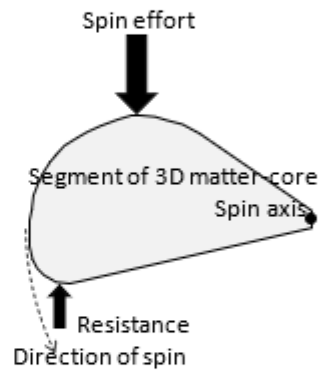

Figure 4.8

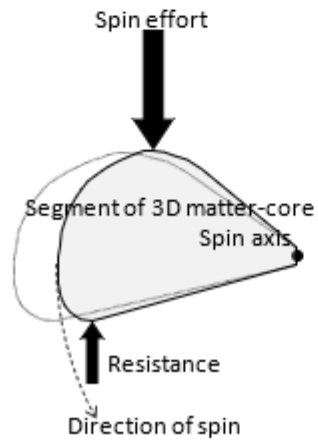

Figure 4.9

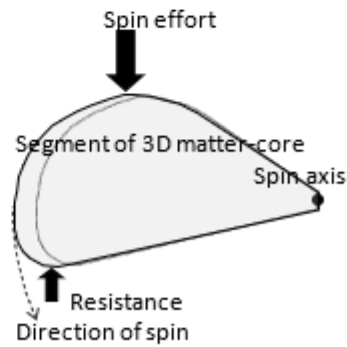

Figure 4.10

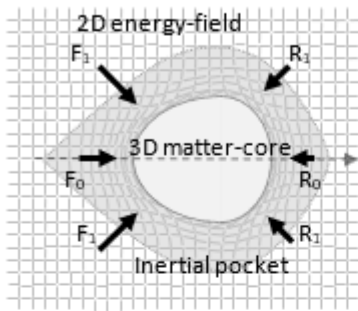

Figure 4.11

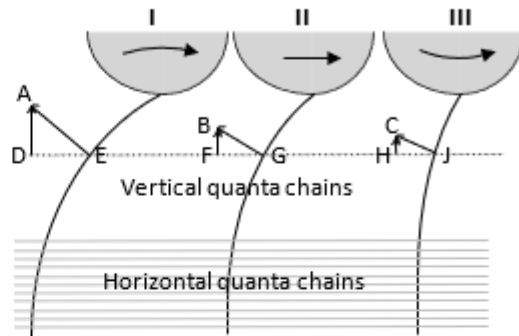

Figure 4.12

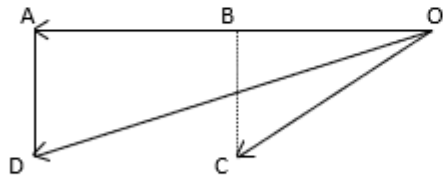

Figure 4.13

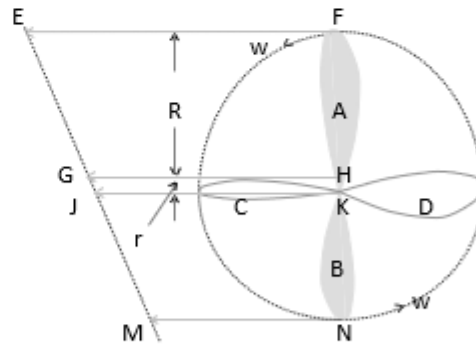

Figure 4.14

INERTIA

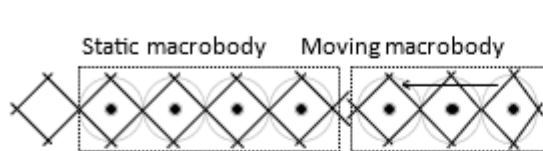

Figure 5.1

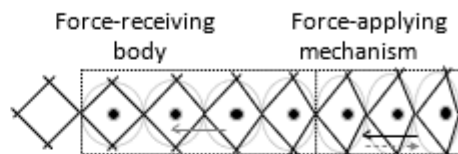

Figure 5.2

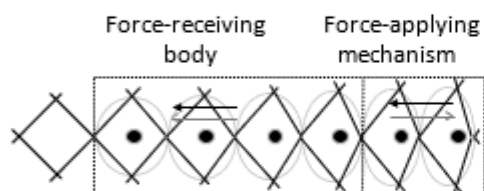

Figure 5.3

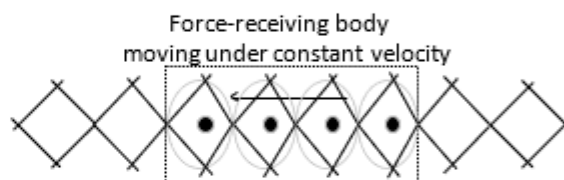

Figure 5.4

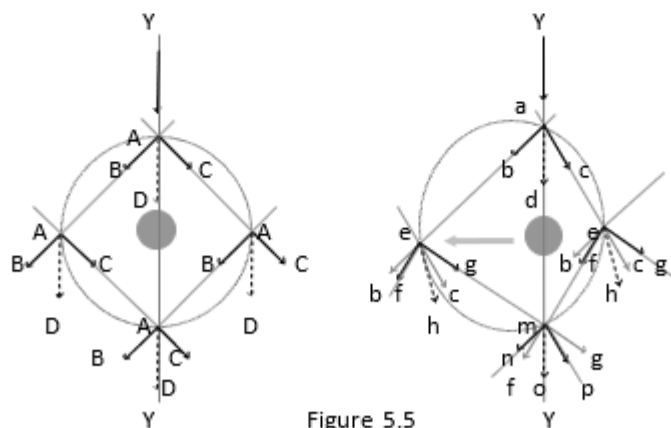

Figure 5.5

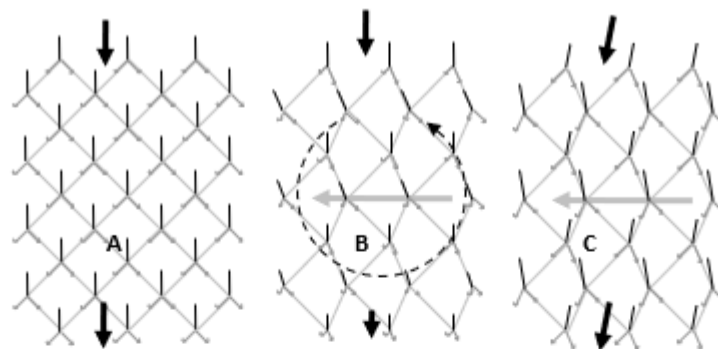

Figure 5.6

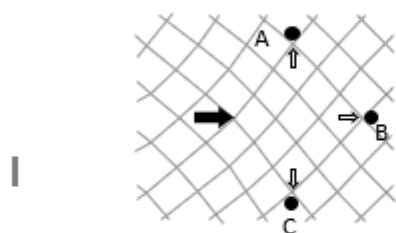
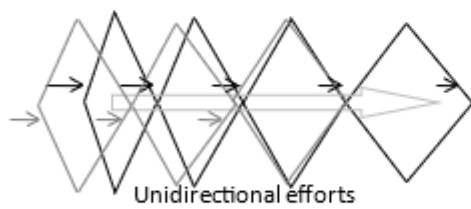
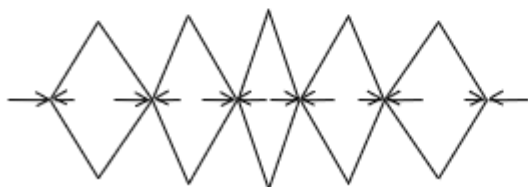

Figure 5.7



Unidirectional efforts

Figure 5.8



Opposite efforts

Figure 5.9

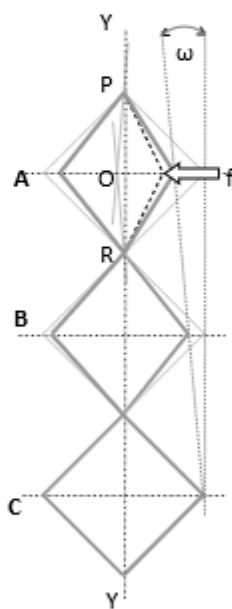

Figure 5.10

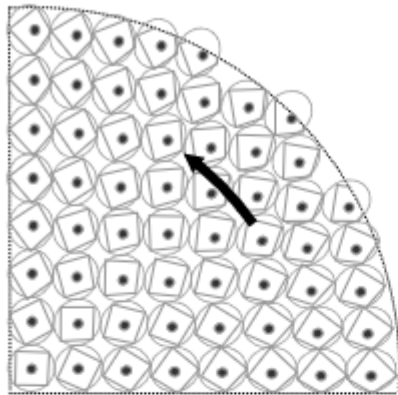

Figure 5.11

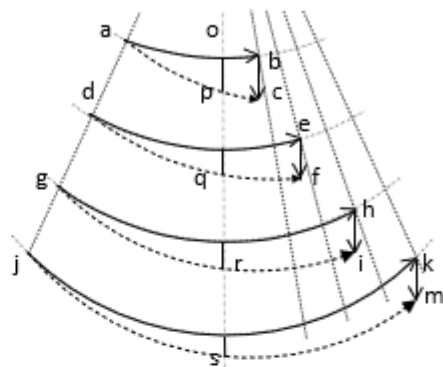

Figure 5.12

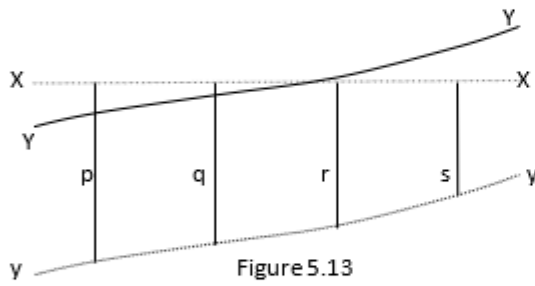

Figure 5.13

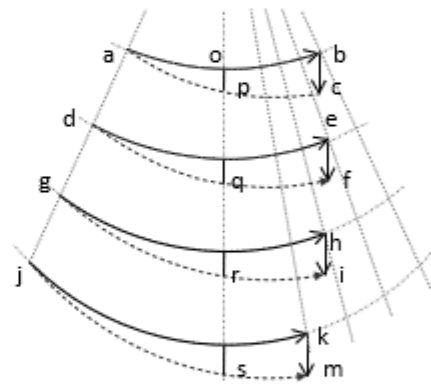

Figure 5.14

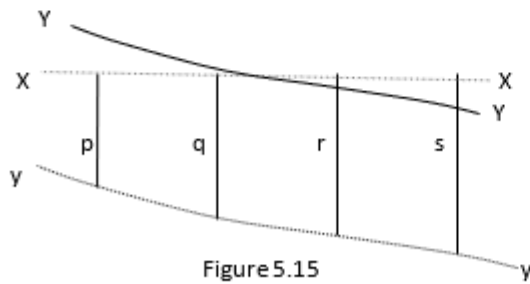

Figure 5.15

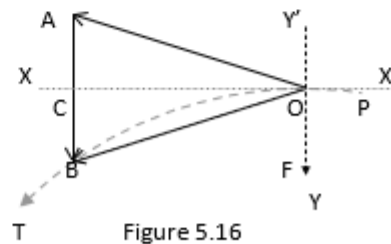

Figure 5.16

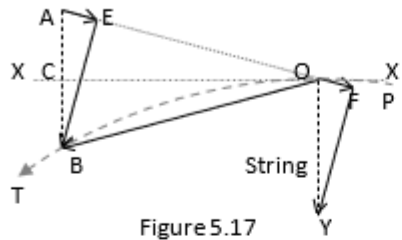

Figure 5.17

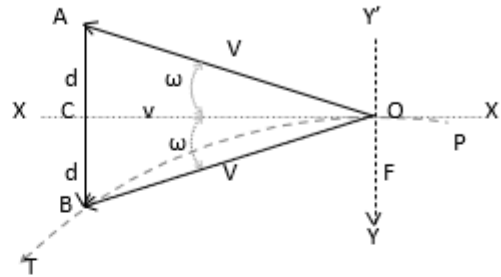

Figure 5.18

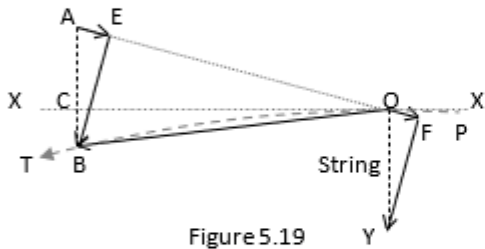

Figure 5.19

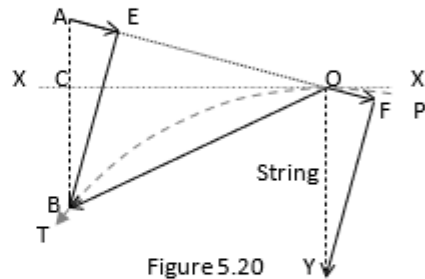

Figure 5.20

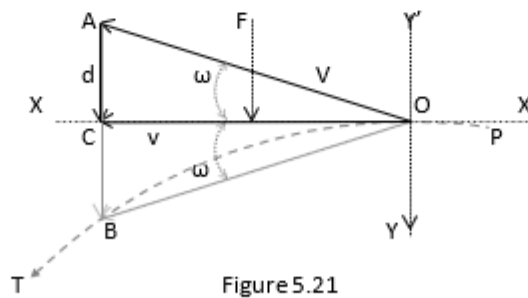

Figure 5.21

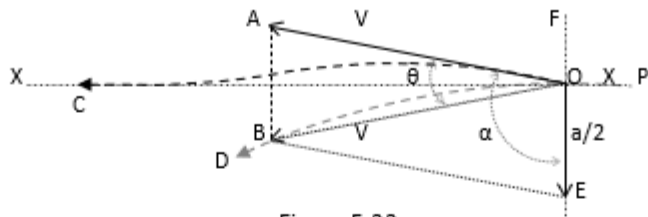

Figure 5.22

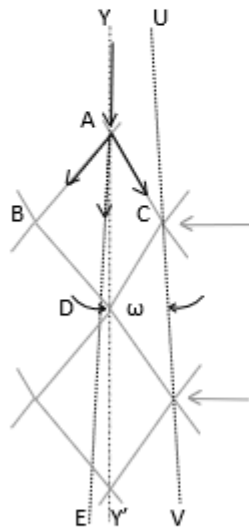

Figure 5.23

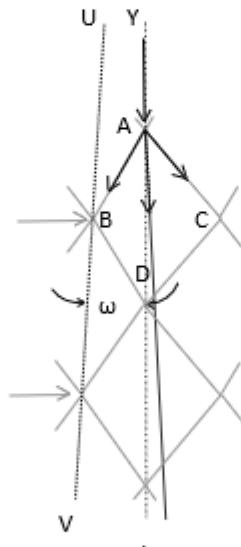

Figure 5.24

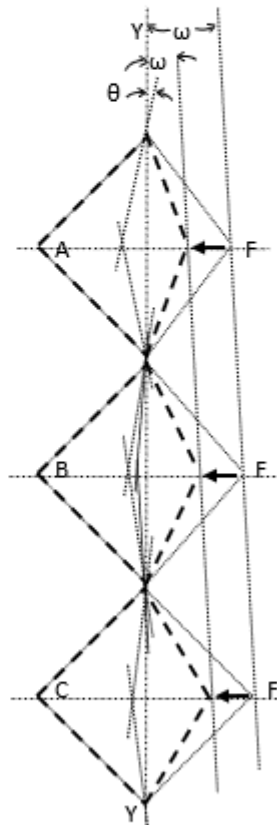

Figure 5.25

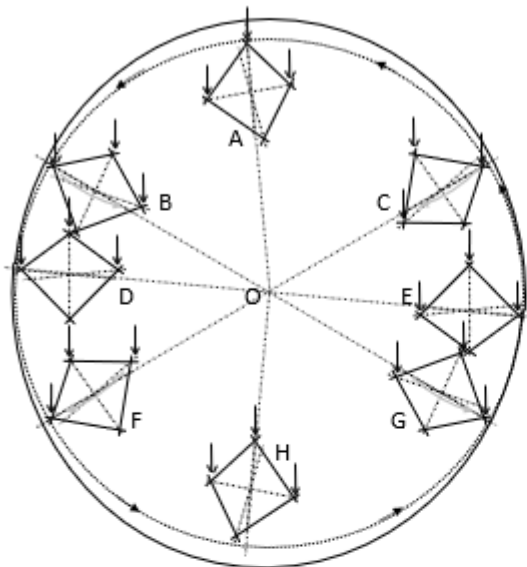

Figure 5.26

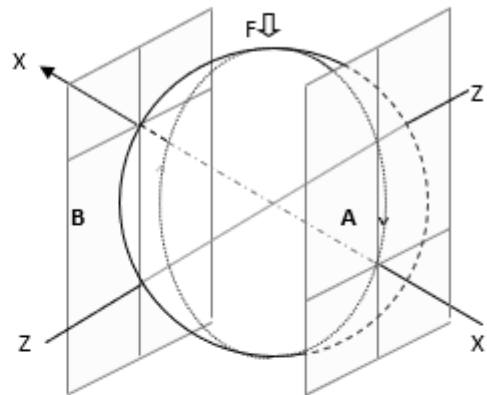

Figure 5.27

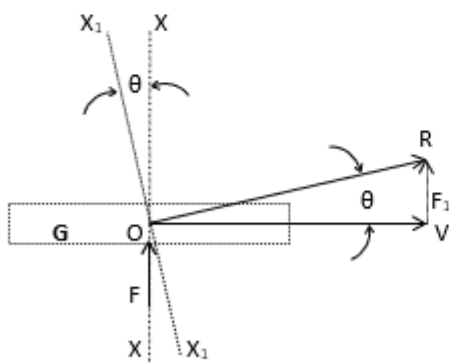

Figure 5.28

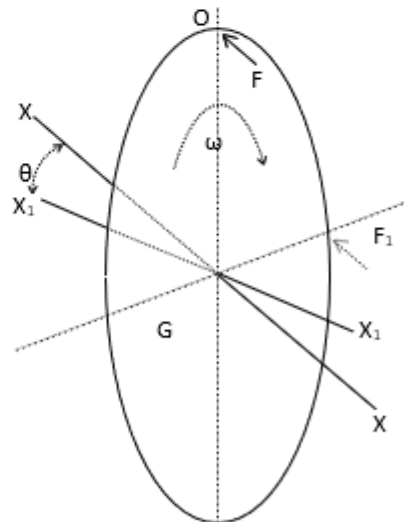

Figure 5.29

RADIATION

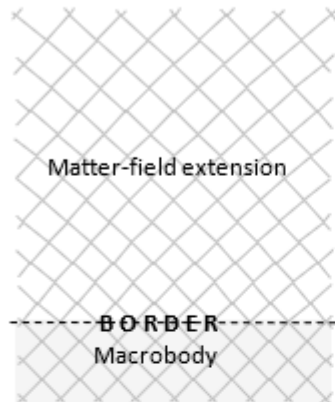

Figure 6.1

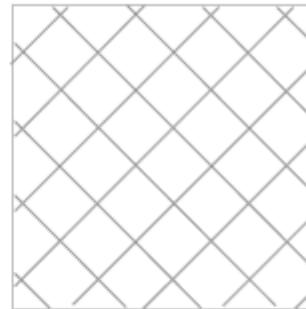

Figure 6.2

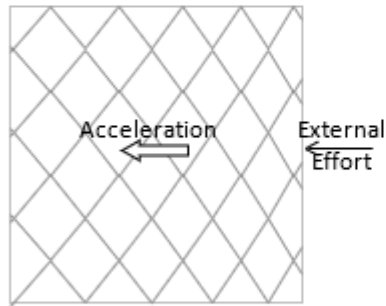

Figure 6.3

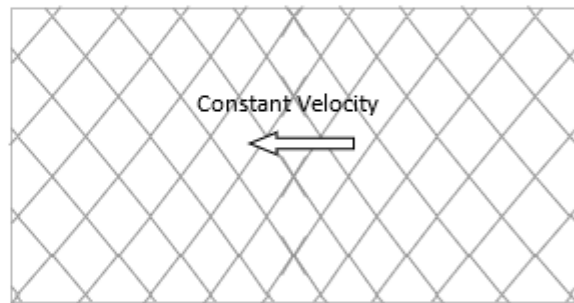

Figure 6.4

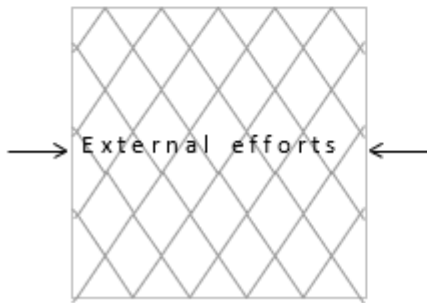

Figure 6.5

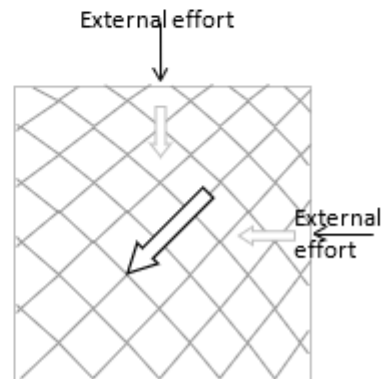

Figure 6.6

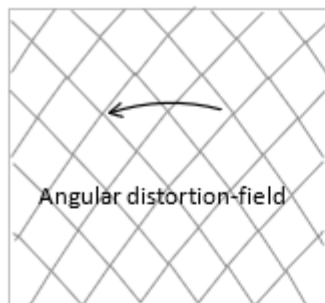

Figure 6.7

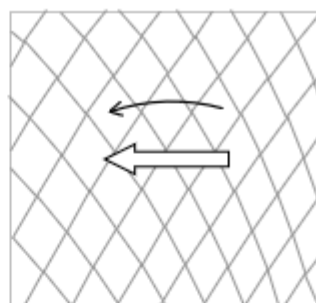

Figure 6.8

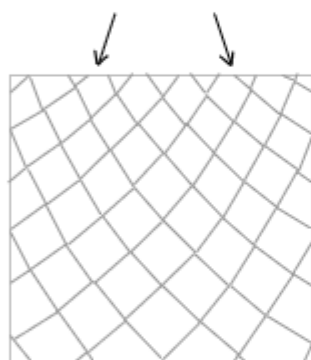

Figure 6.9

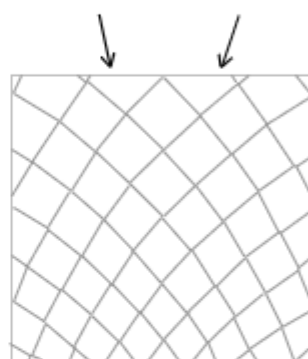

Figure 6.10

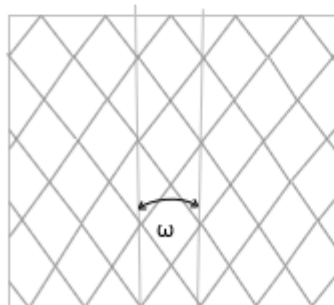

Figure 6.11



Figure 6.12



Figure 6.13



Figure 6.15



Figure 6.14

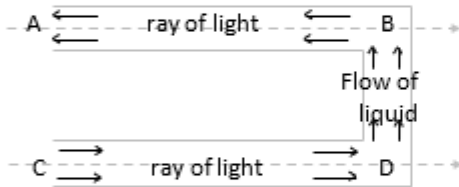

Figure 6.16

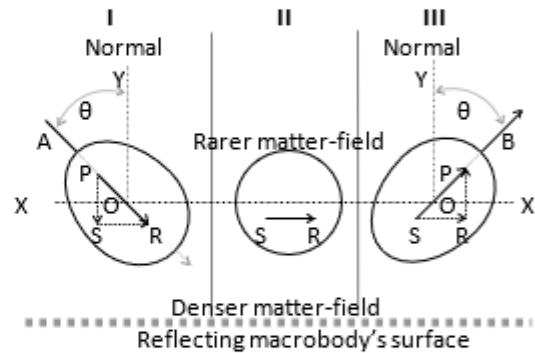

Figure 6.17

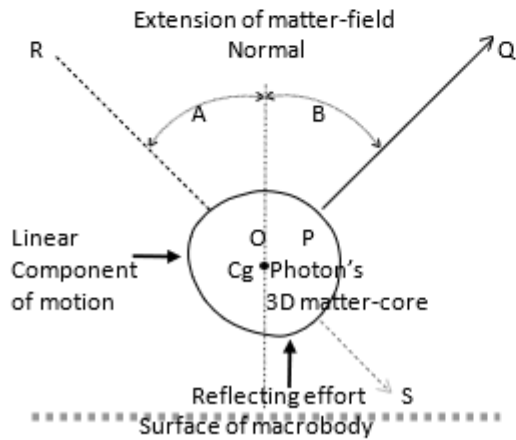

Figure 6.18

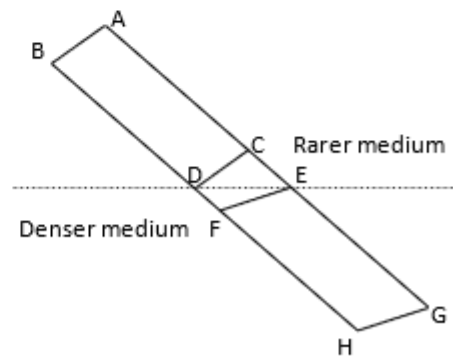

Figure 6.19

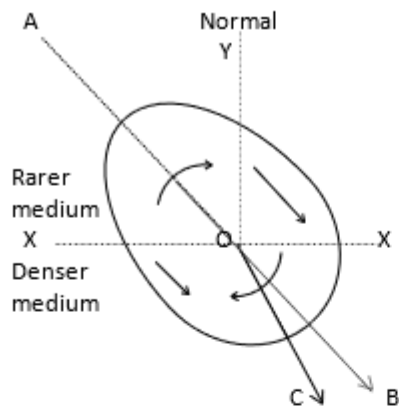

Figure 6.20

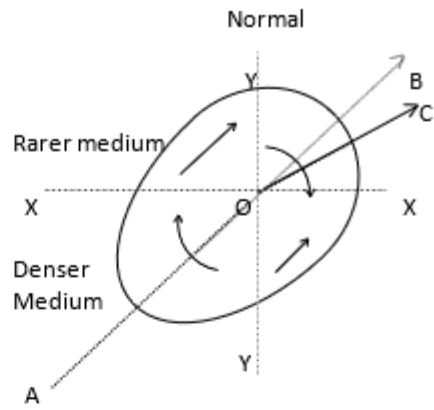

Figure 6.21

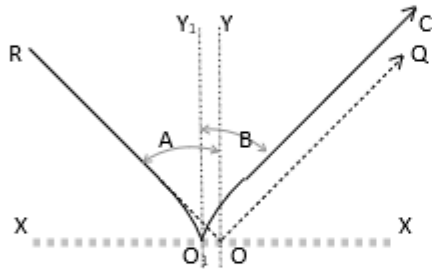

Figure 6.22



Figure 6.24

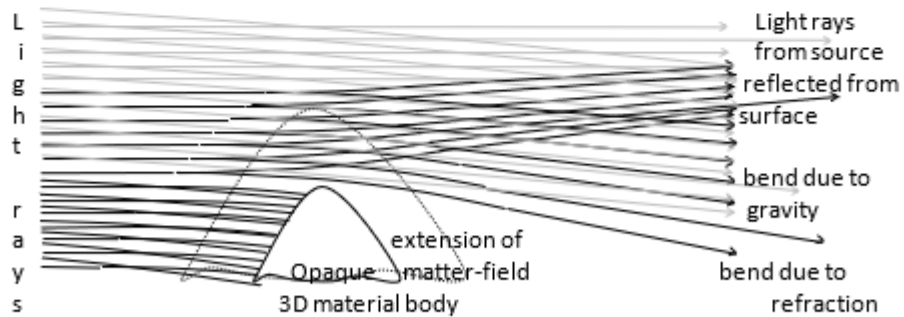

Figure 6.23

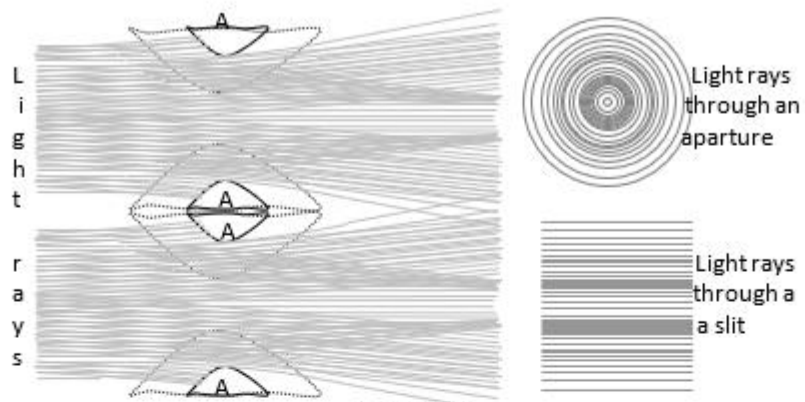

Figure 6.25

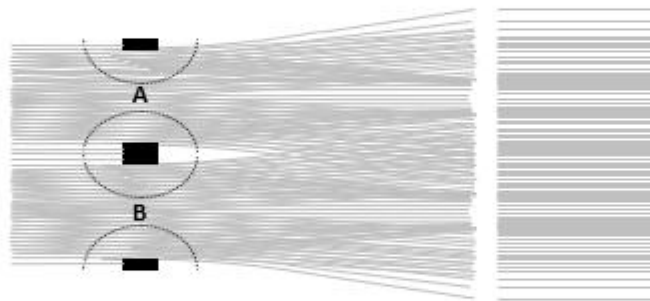

Figure 6.26

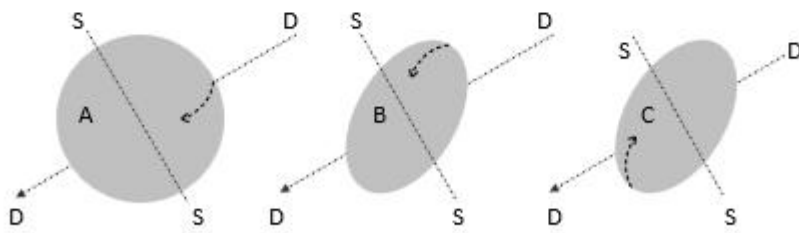

Figure 6.27

GRAVITATIONAL ATTRACTION

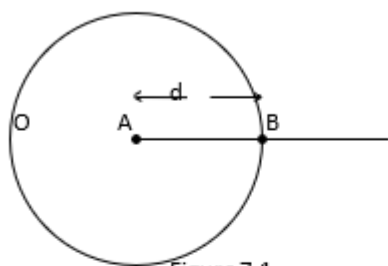

Figure 7.1

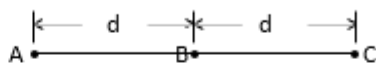

Figure 7.2

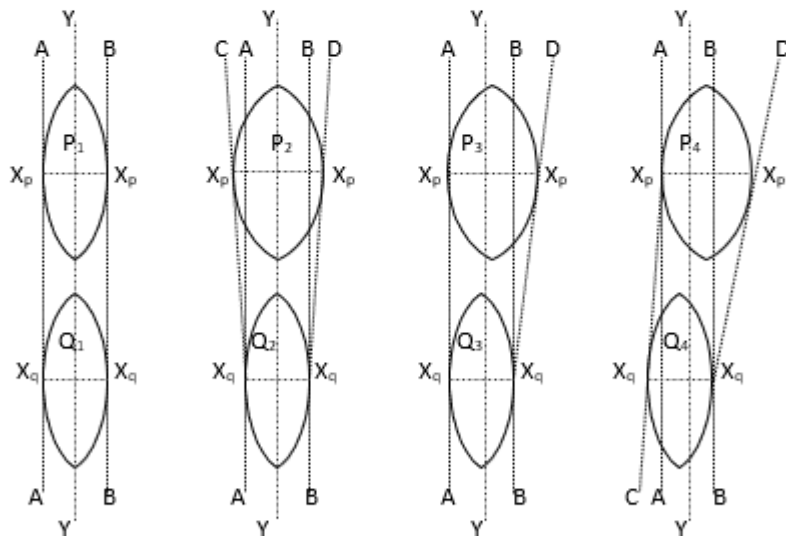

Figure 7.3

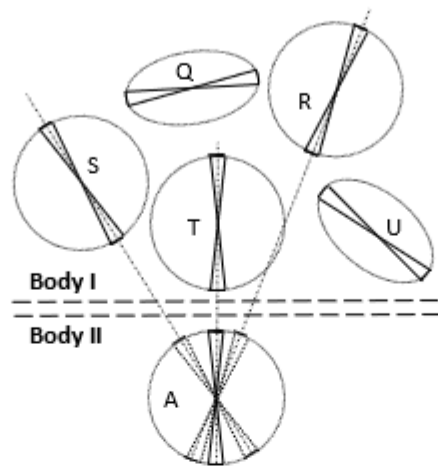

Figure 7.4

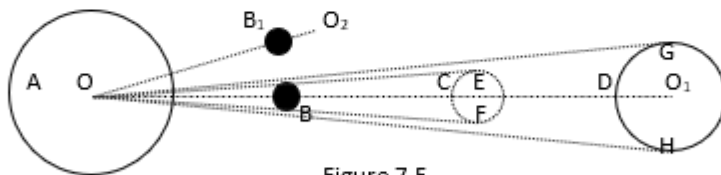

Figure 7.5

DISTORTION-FIELDS

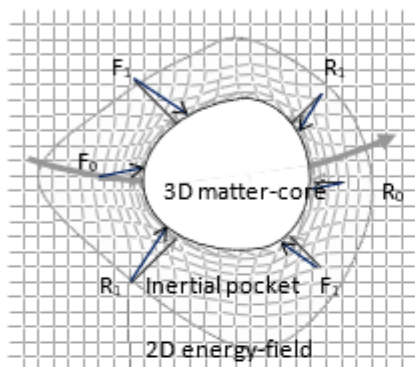

Figure 8.1

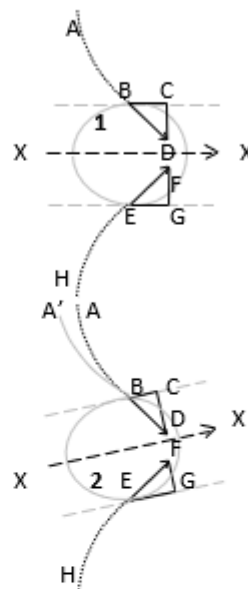

Figure 8.2

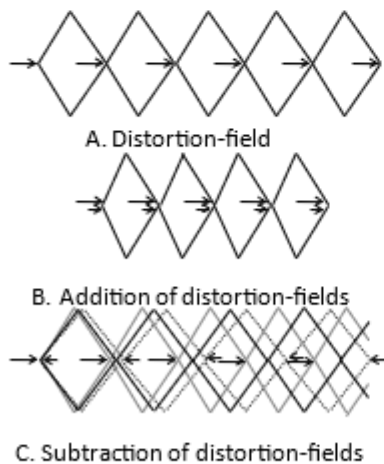

Figure 8.3

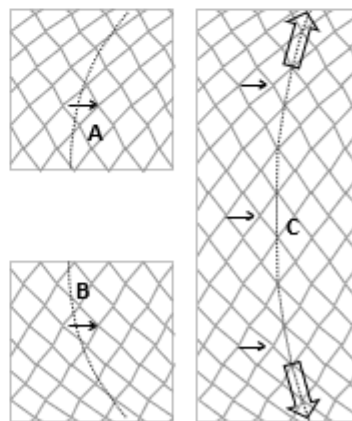

Figure 8.4

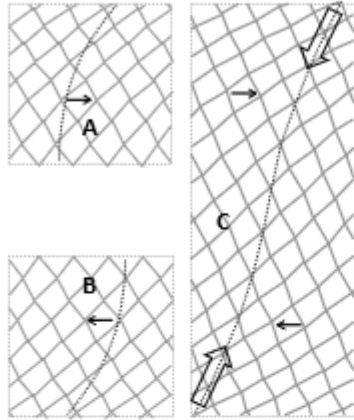

Figure 8.5

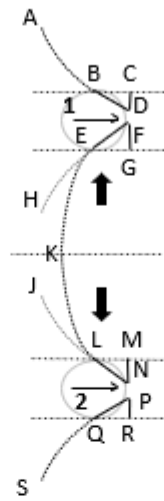

Figure 8.6

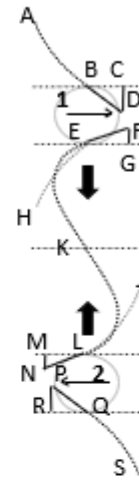

Figure 8.7

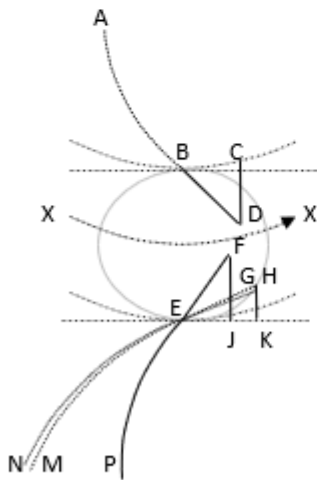

Figure 8.8

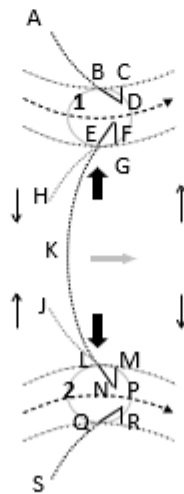

Figure 8.9

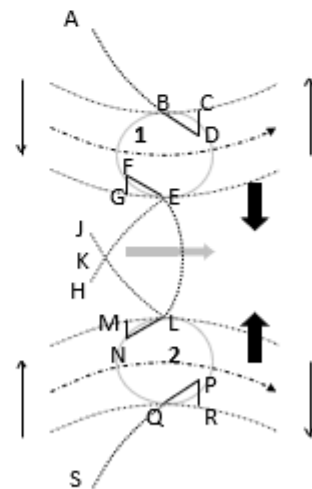

Figure 8.10

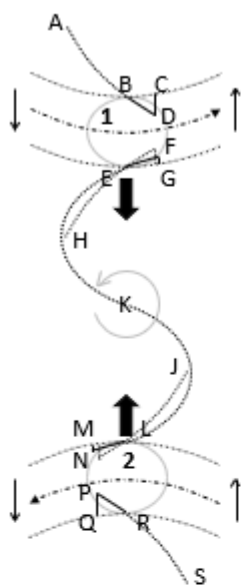

Figure 8.11

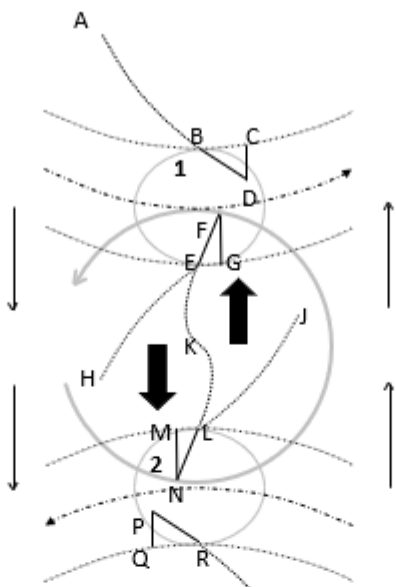

Figure 8.12

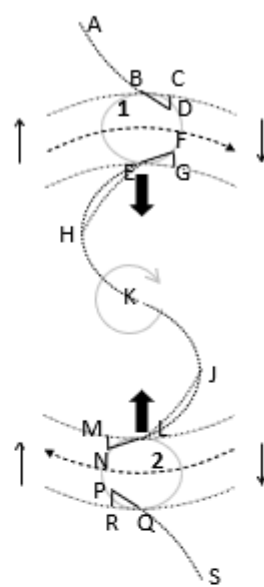

Figure 8.13

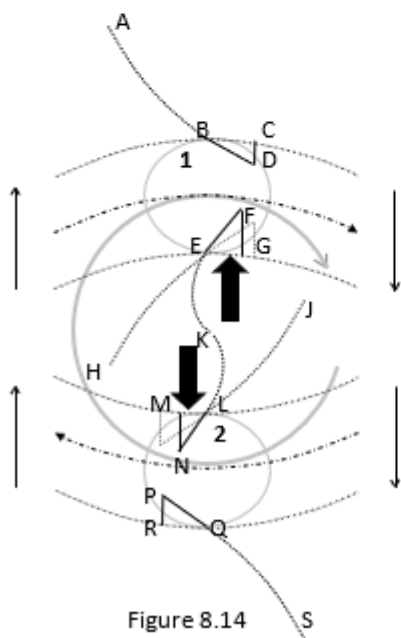

Figure 8.14

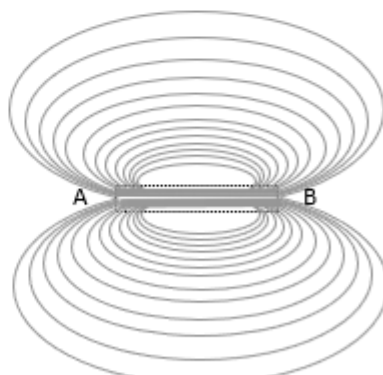

Figure 8.15

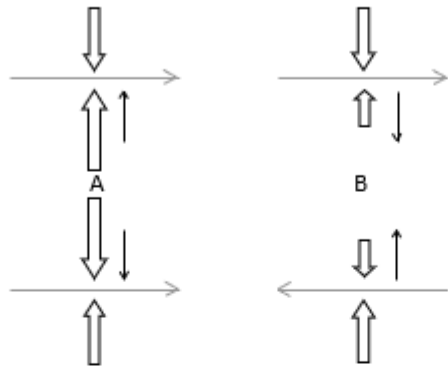

Figure 8.16

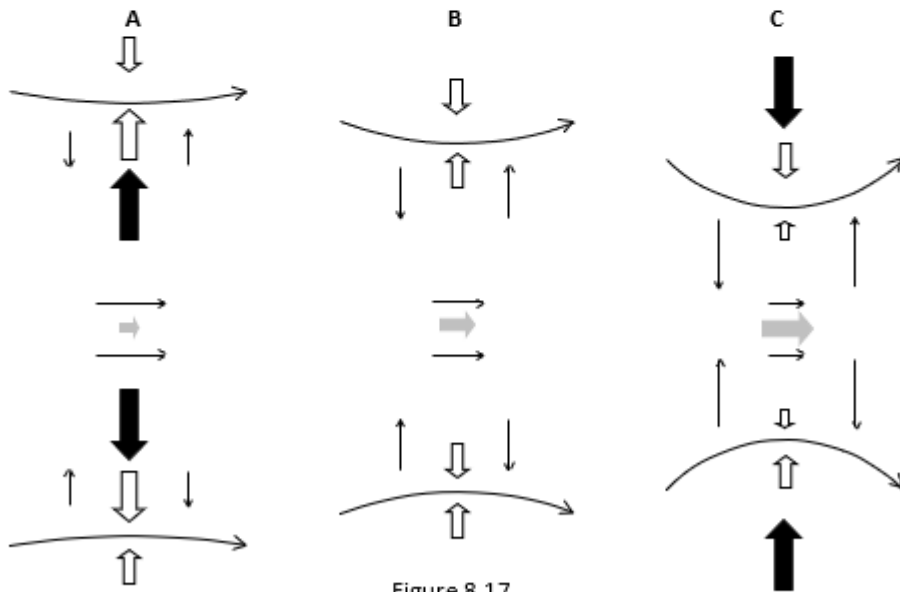

Figure 8.17

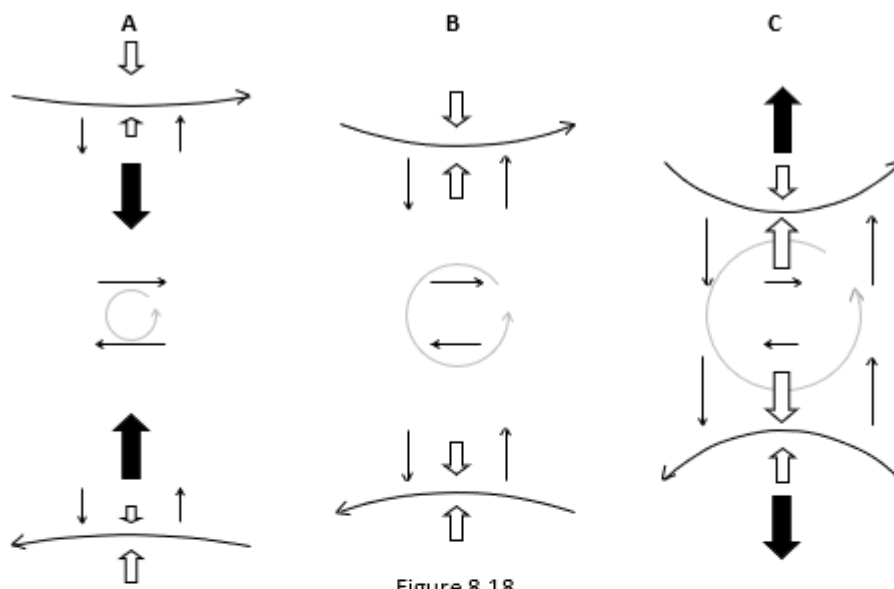

Figure 8.18

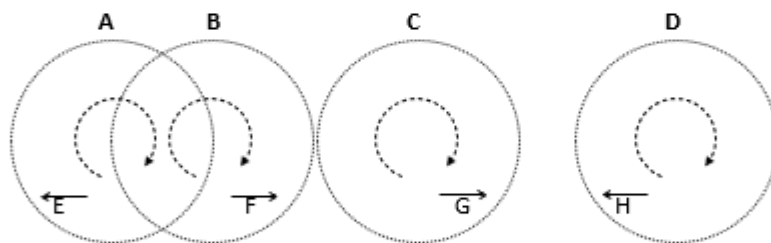

Figure 8.19

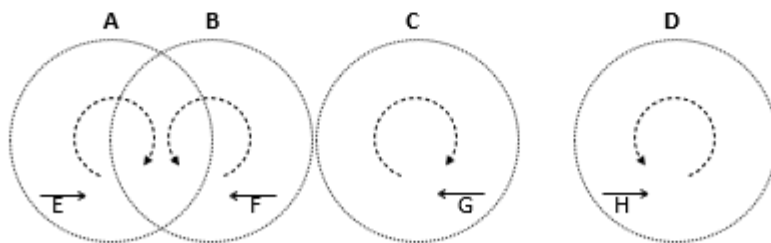

Figure 8.20

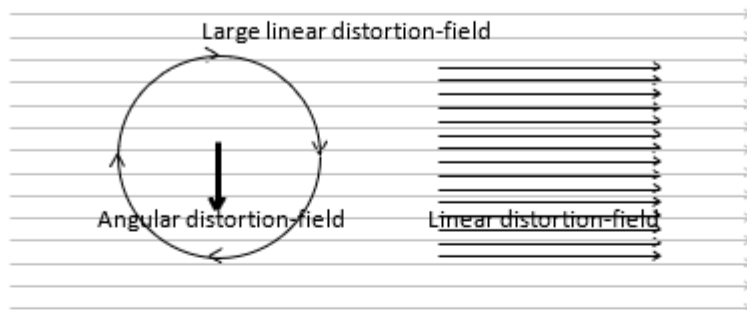

Figure 8.21

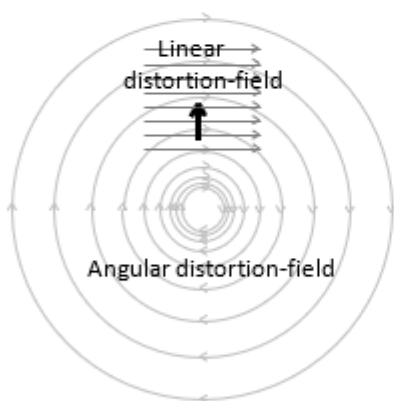

Figure 8.22

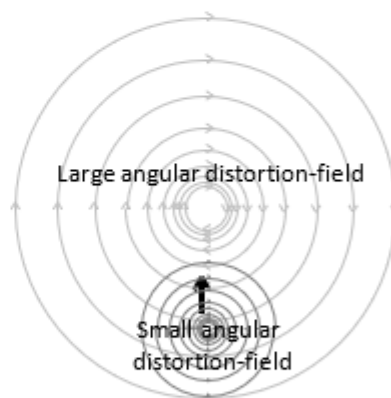

Figure 8.23

Biton

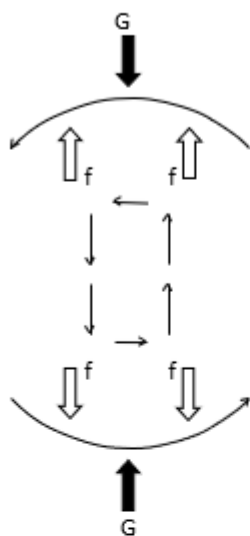

Figure 9.1

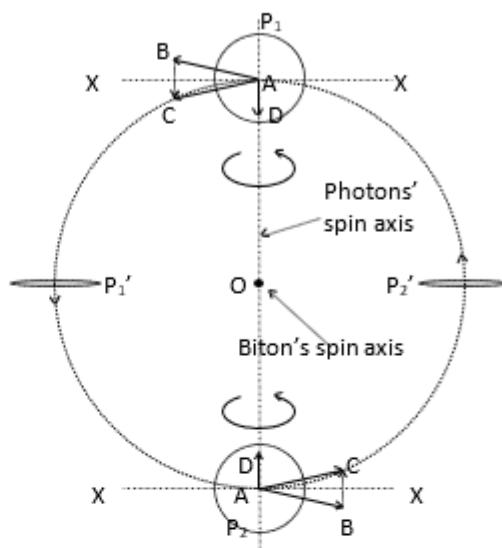

Figure 9.2

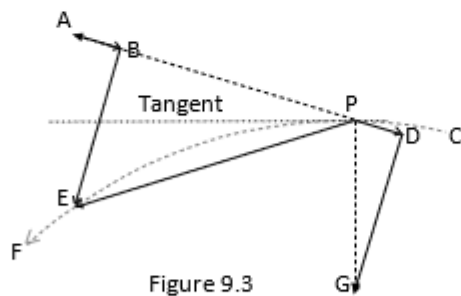

Figure 9.3

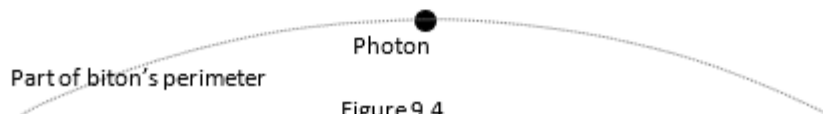
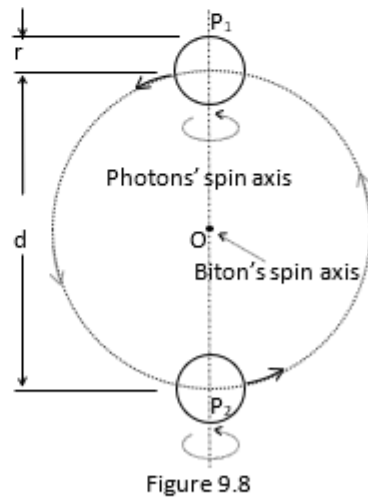
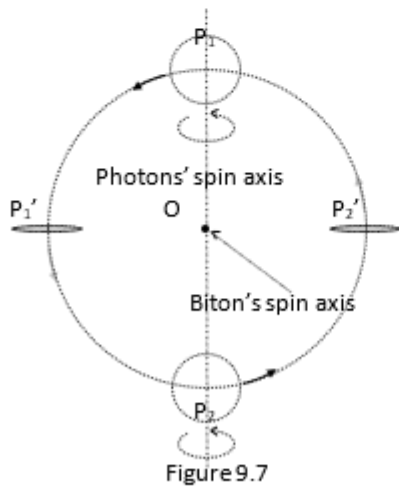
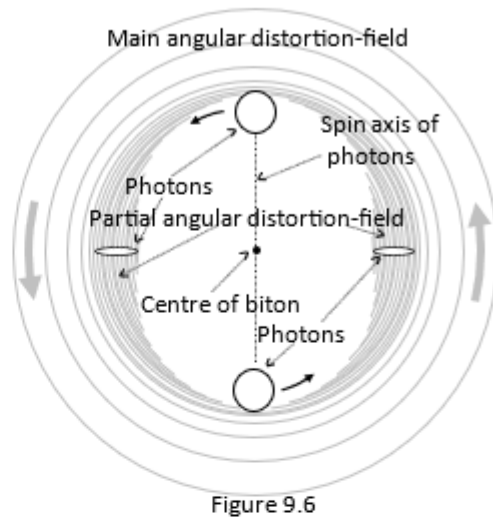
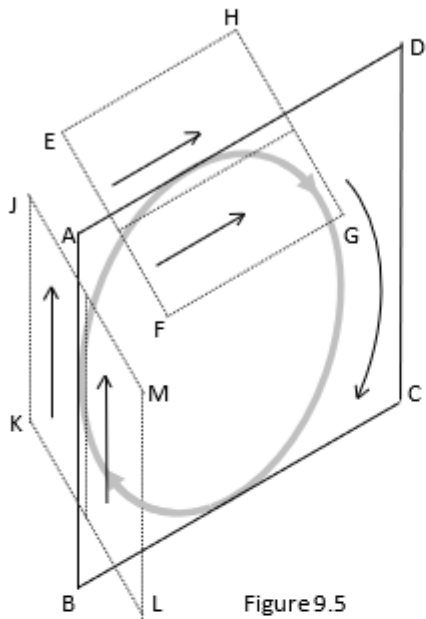
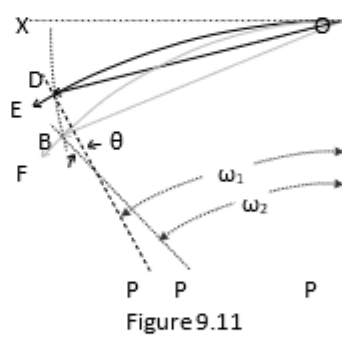
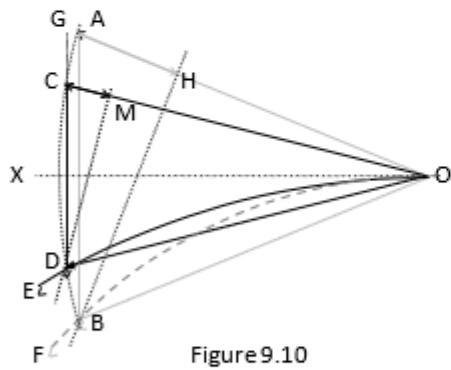
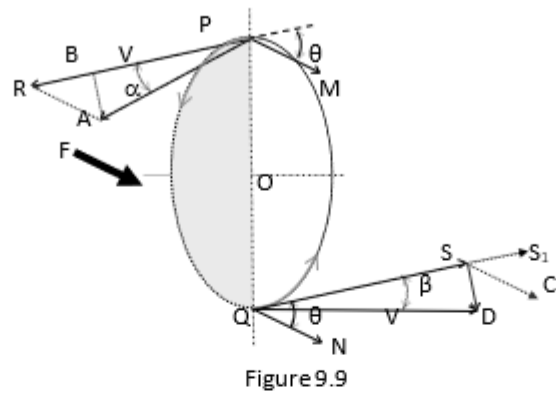

Figure 9.4





TETRON

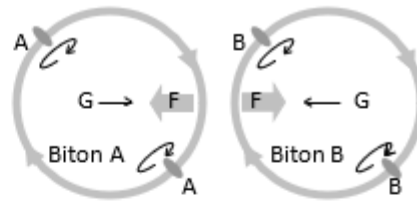

Figure 10.1

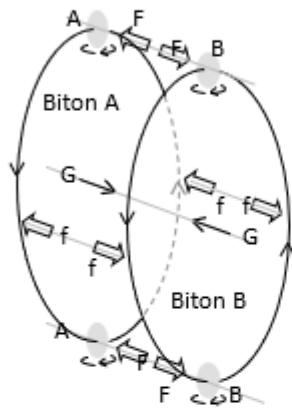

Figure 10.2

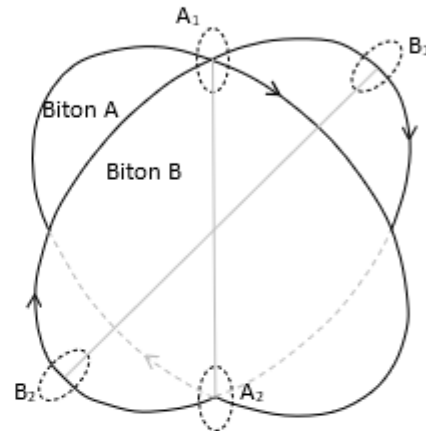

Figure 10.3

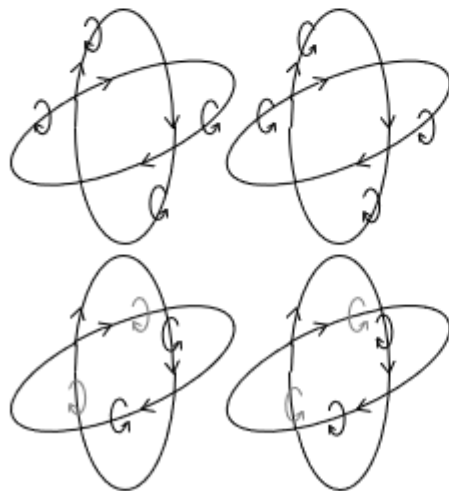

Figure 10.4

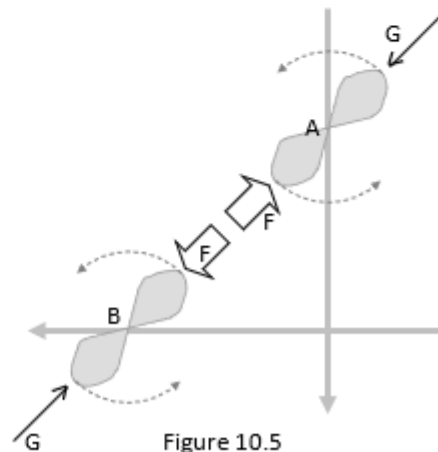

Figure 10.5

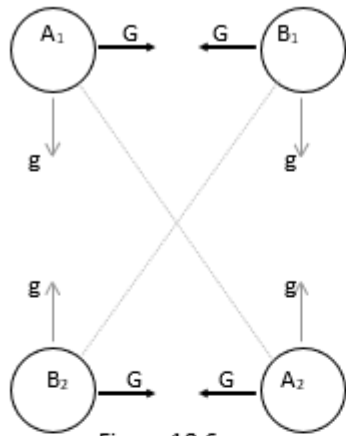

Figure 10.6

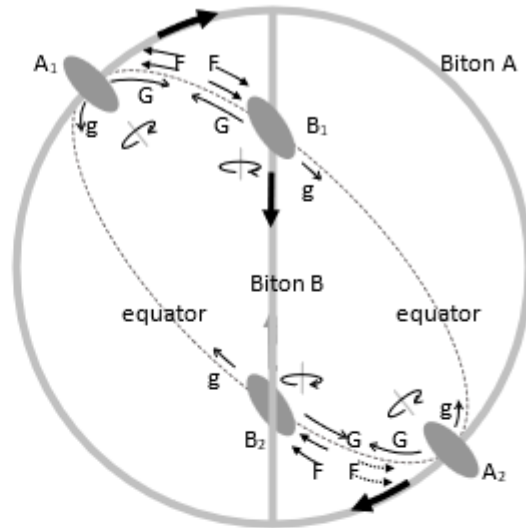

Figure 10.7

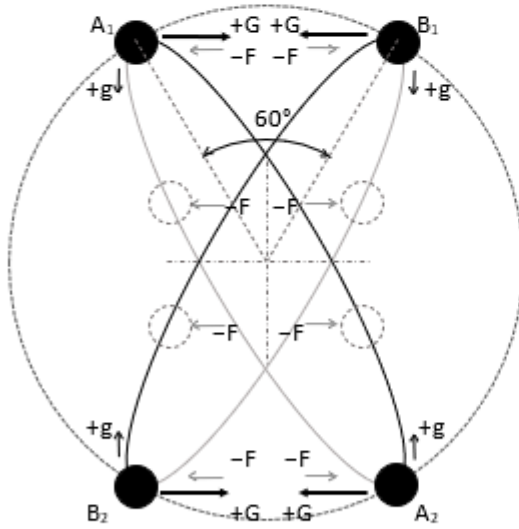

Figure 10.8

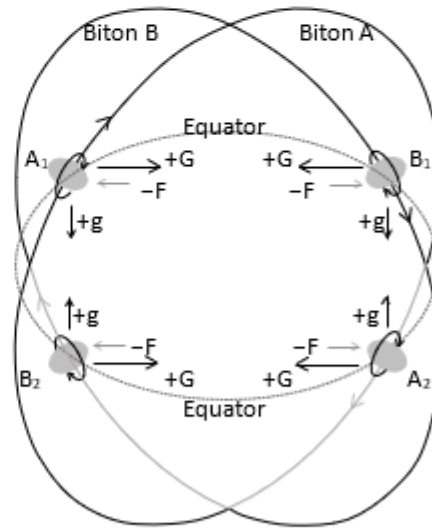

Figure 10.9

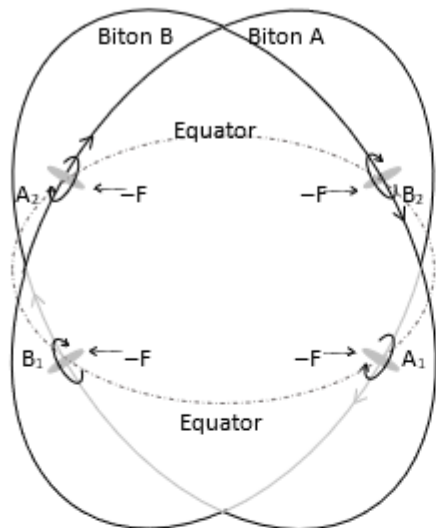

Figure 10.10

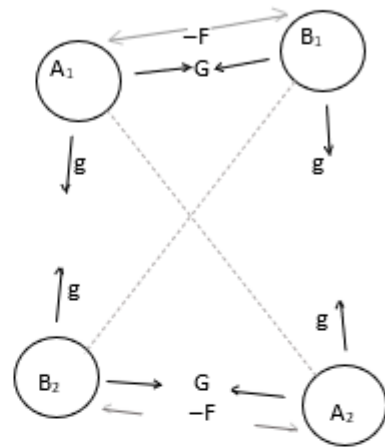

Figure 10.11

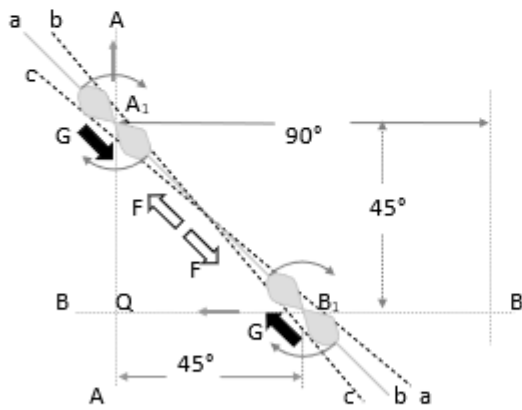

Figure 10.12

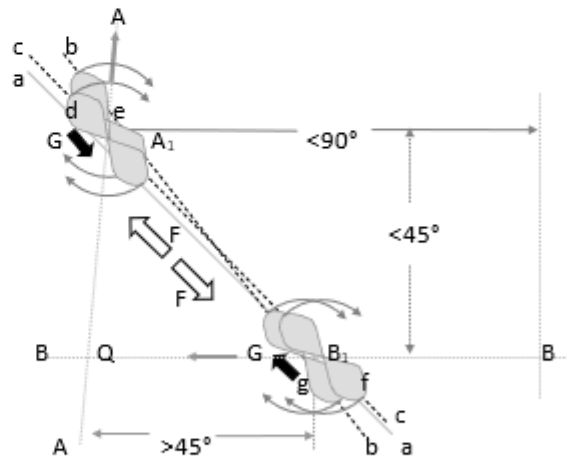

Figure 10.13

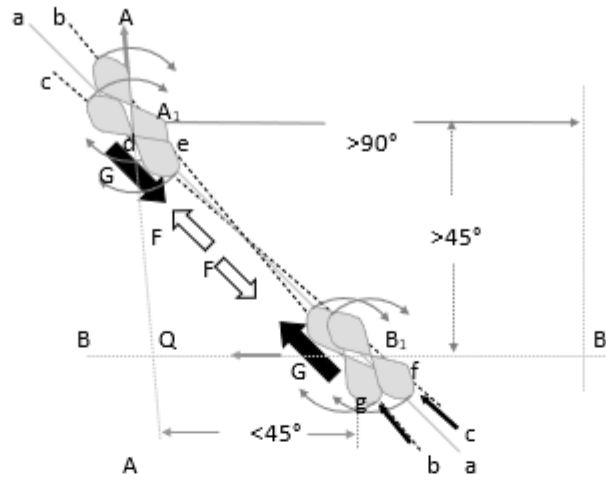

Figure 10.14

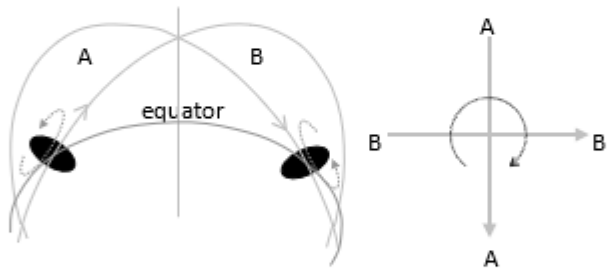

Figure 10.15

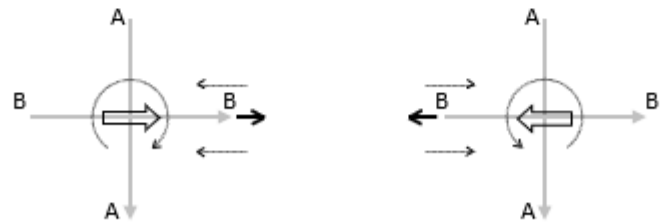

Figure 10.16

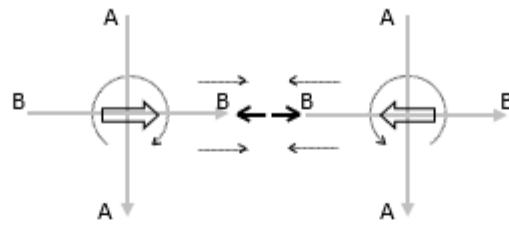

Figure 10.17

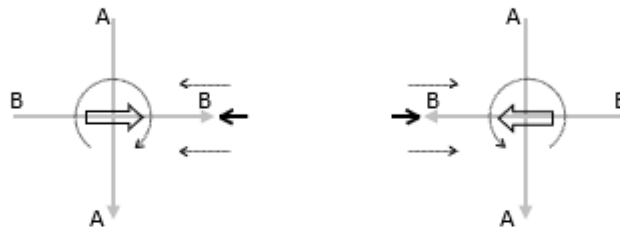

Figure 10.18

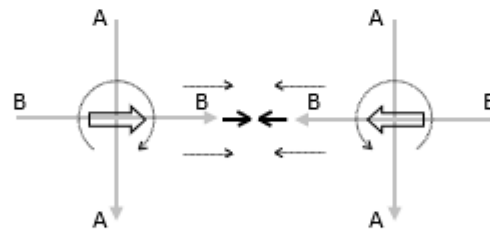

Figure 10.19

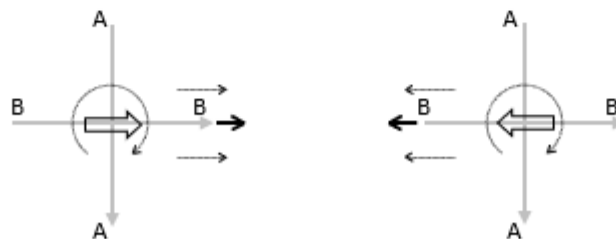

Figure 10.20

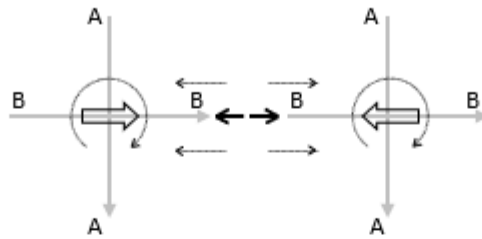

Figure 10.21

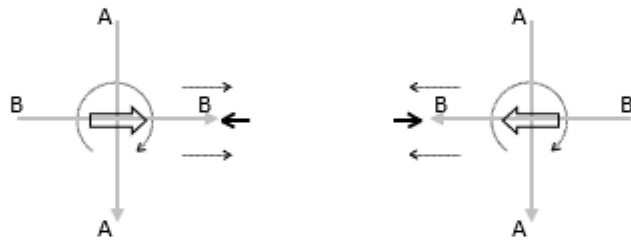

Figure 10.22

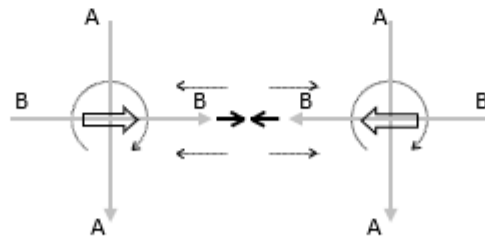

Figure 10.23

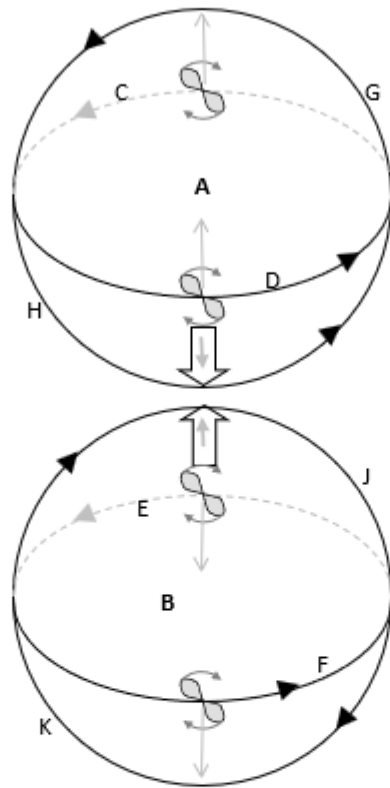

Figure 10.24

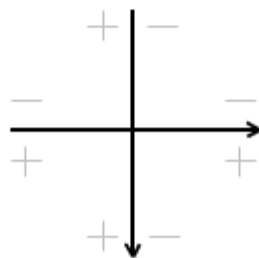

Figure 10.25

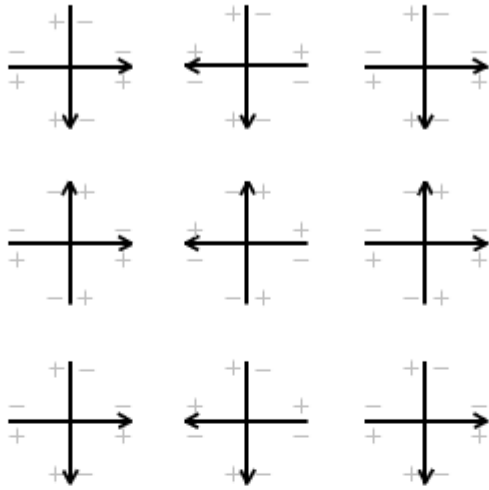

Figure 10.26

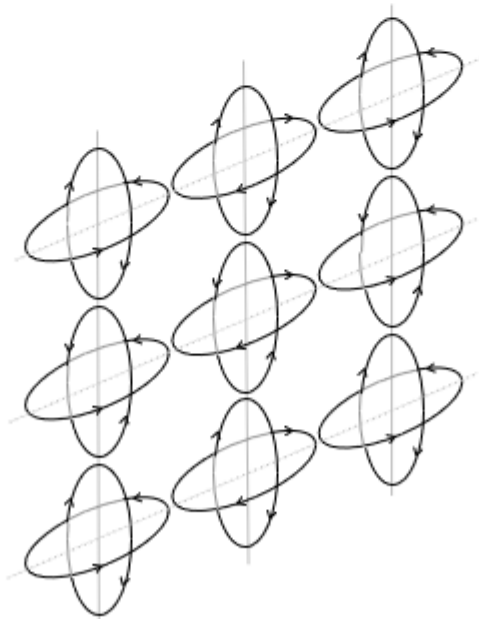

Figure 10.27

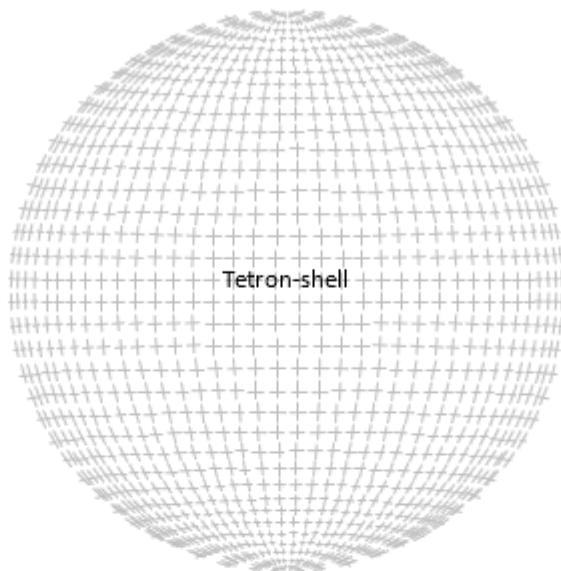

Figure 10.28

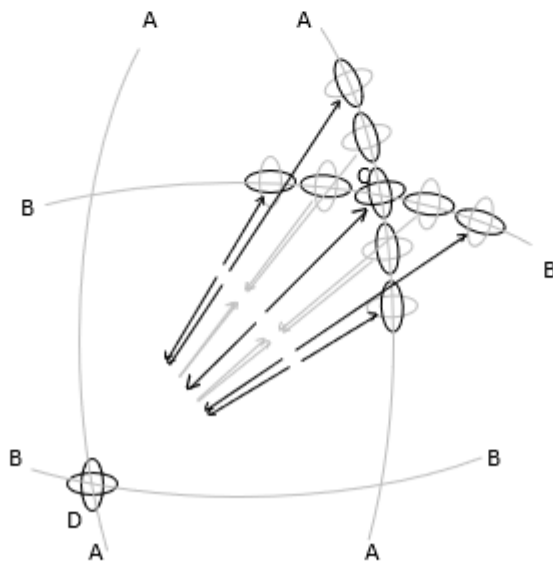

Figure 10.29

FIELD-EFFORT

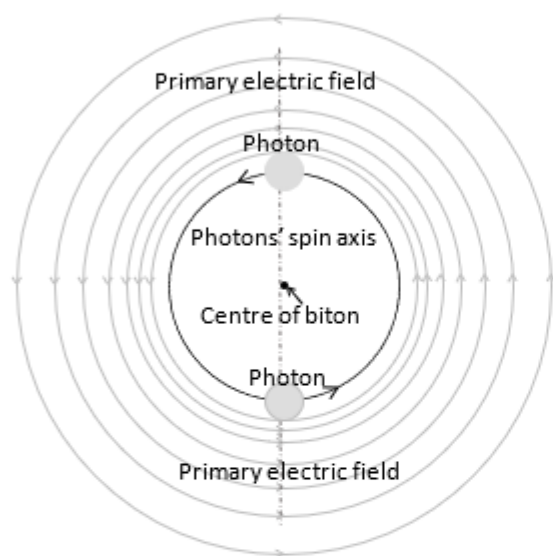

Figure 11.1

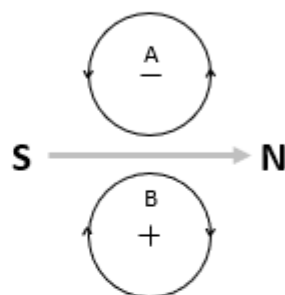

Figure 11.2

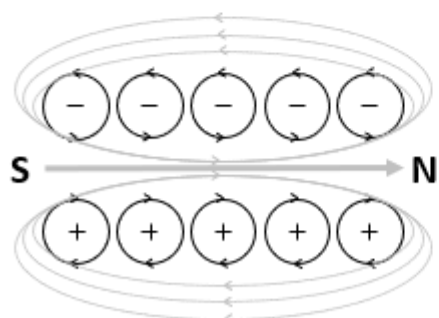

Figure 11.3

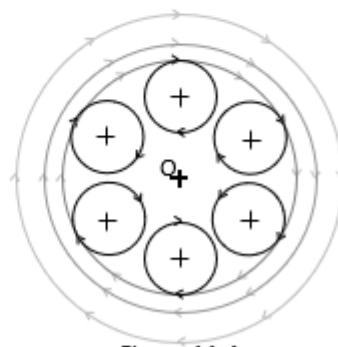

Figure 11.4

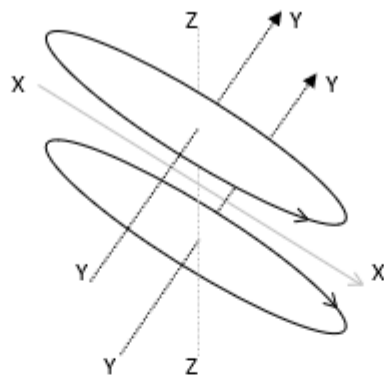

Figure 11.5

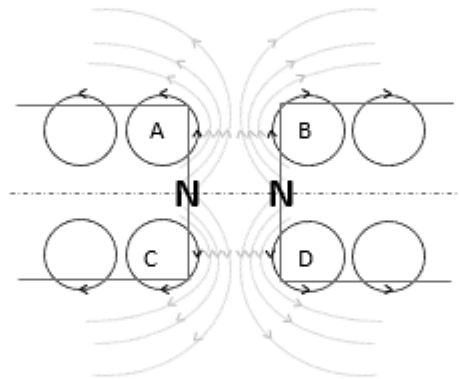

Figure 11.6

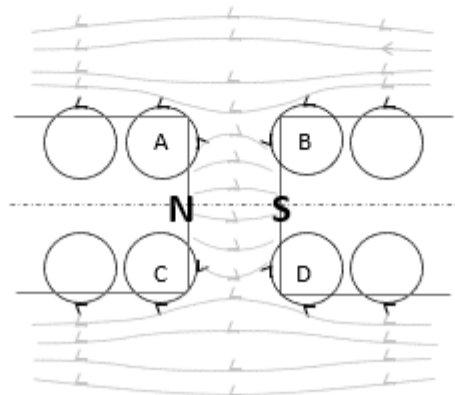

Figure 11.7

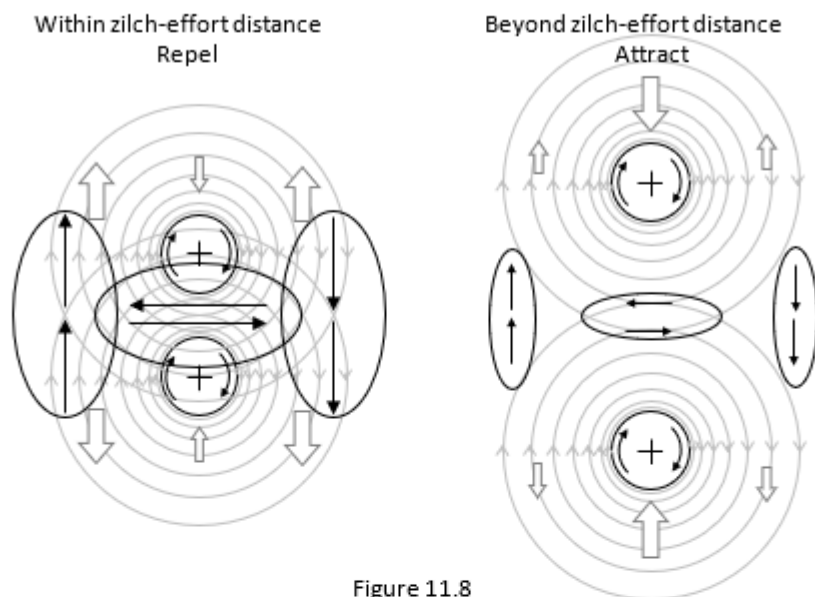

Figure 11.8

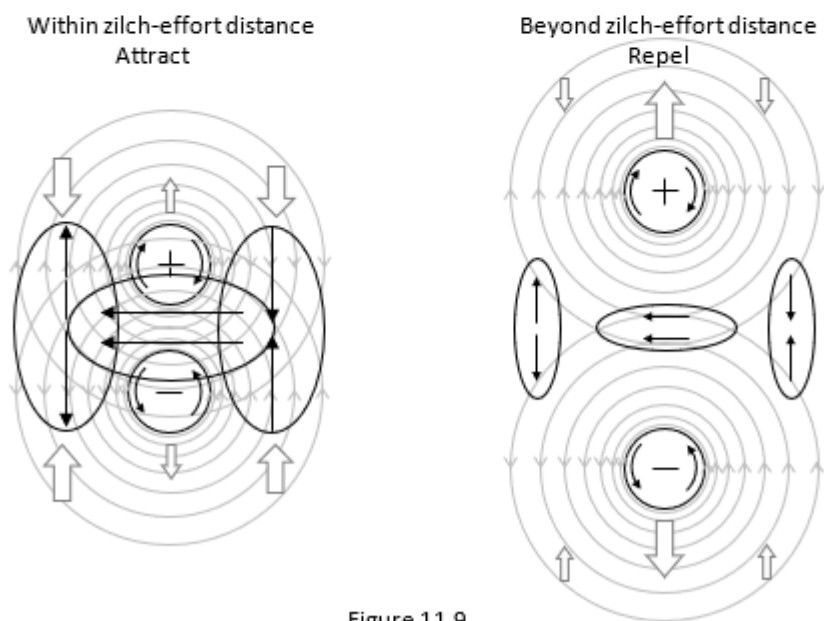

Figure 11.9

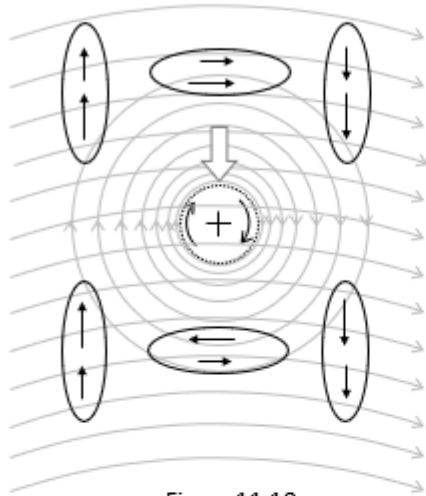

Figure 11.10

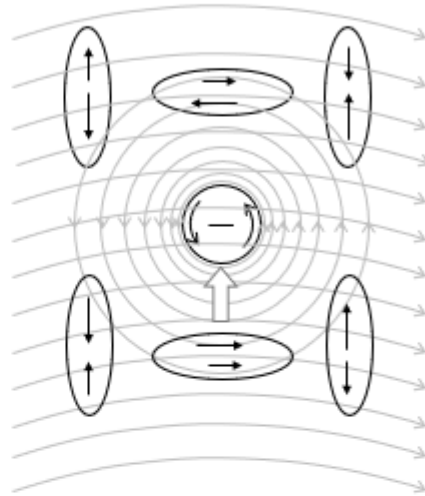

Figure 11.11

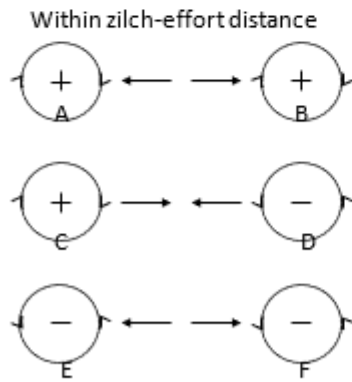

Figure 11.12

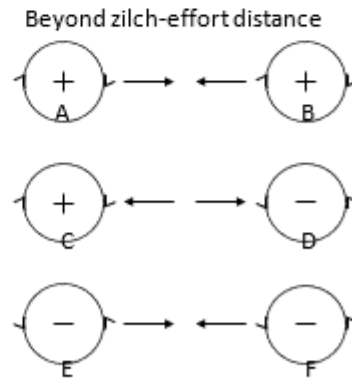

Figure 11.13

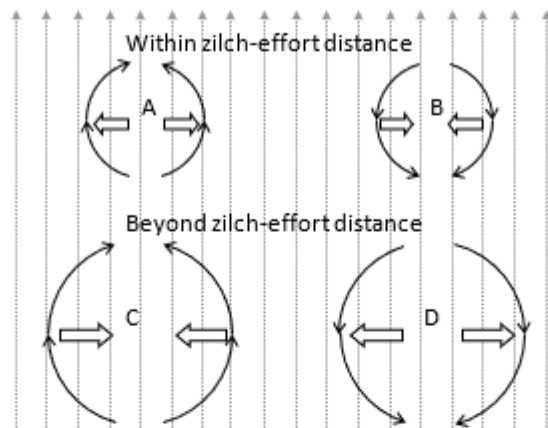

Figure 11.14

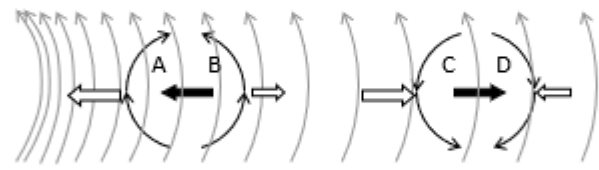

Figure 11.15

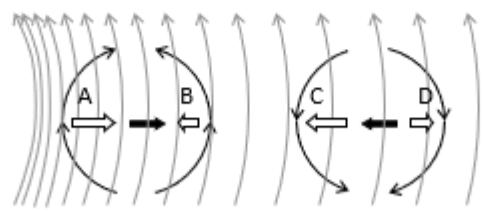

Figure 11.16

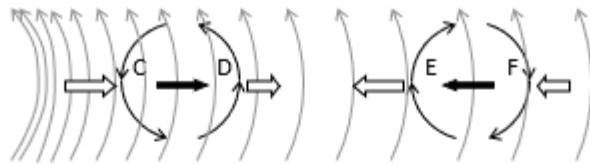

Figure 11.17

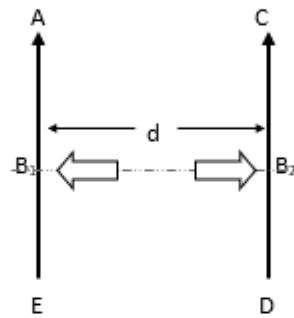

Figure 11.18

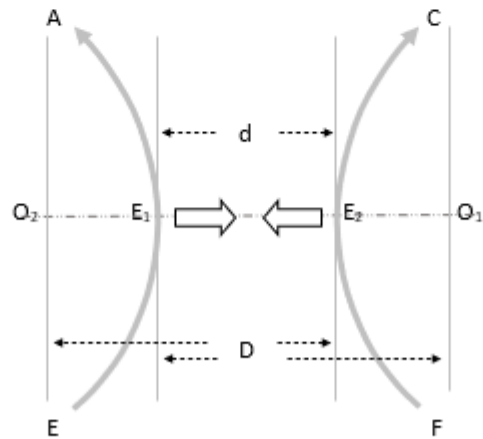

Figure 11.19

HEXTON

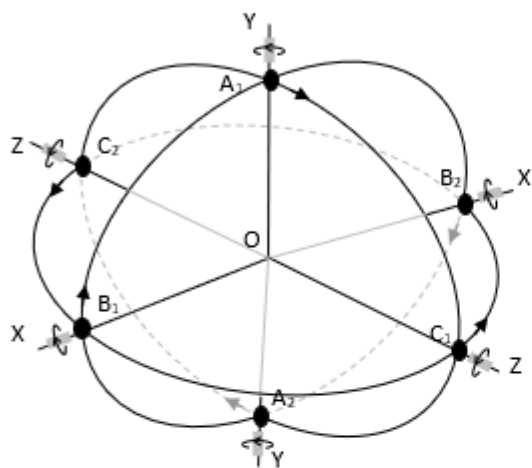

Figure 12.1

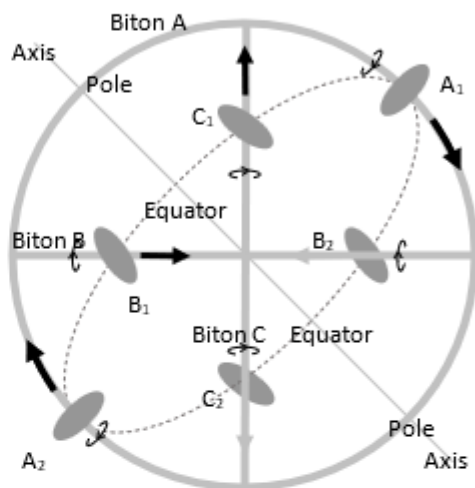

Figure 12.2

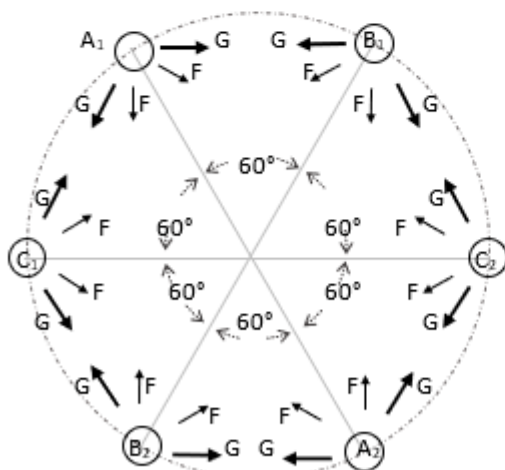
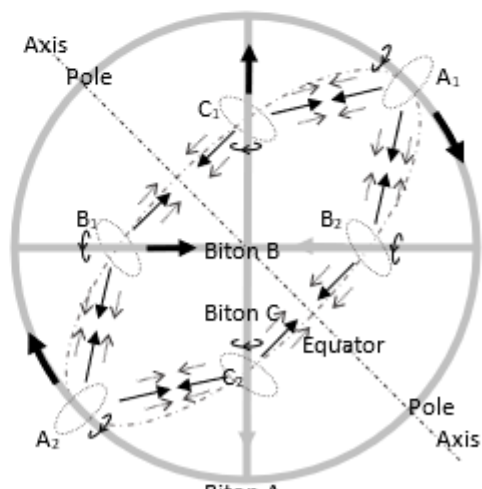

Figure 12.3



Biton A
Figure 12.4

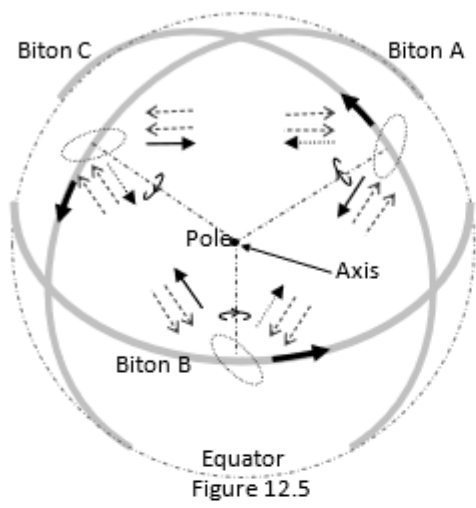

Figure 12.5

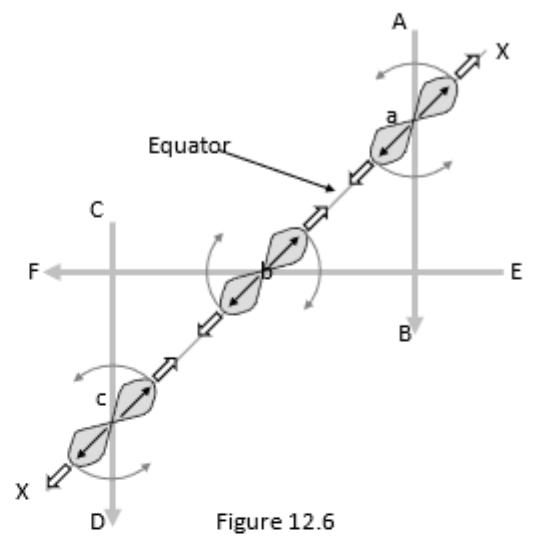

Figure 12.6

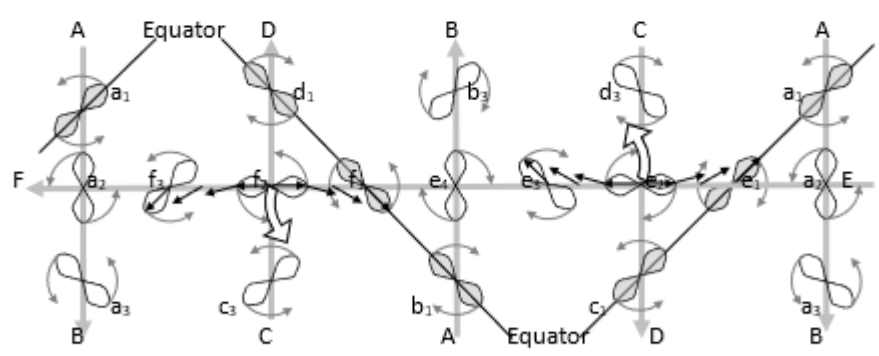

Figure 12.7

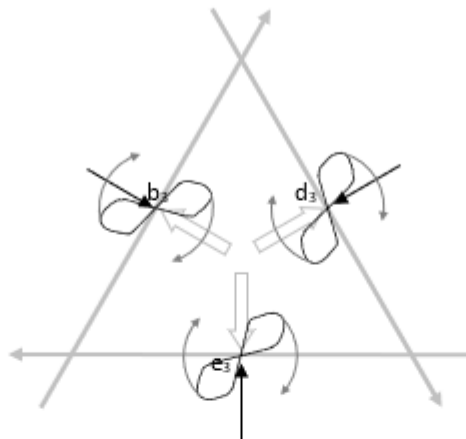

Figure 12.8

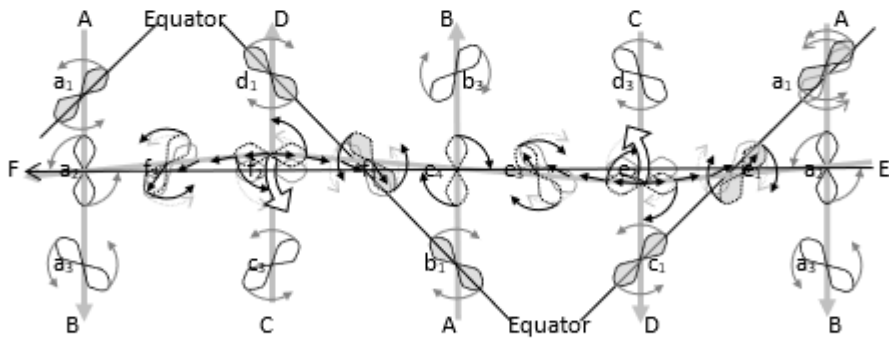

Figure 12.9

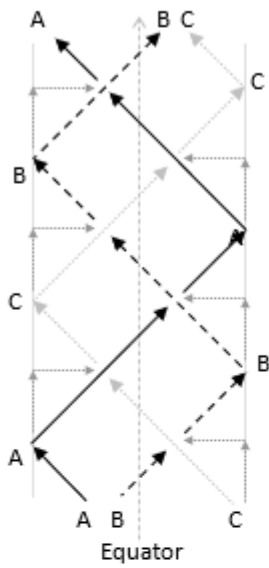

Figure 12.10

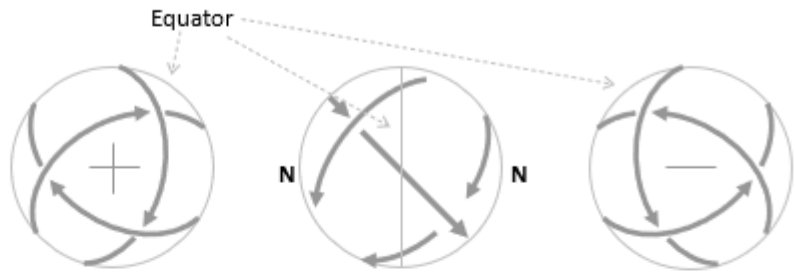
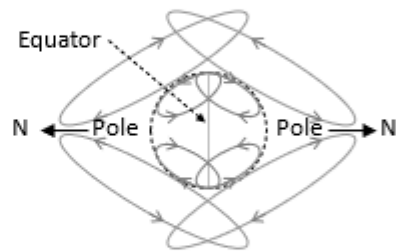
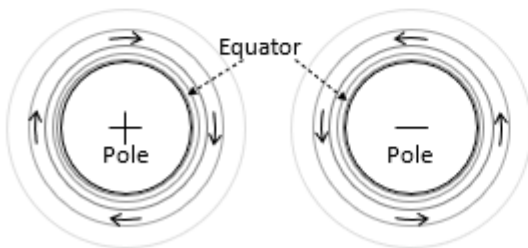

Figure 12.11



Positron's magnetic field
Figure 12.12



Positron's electric field
Figure 12.13

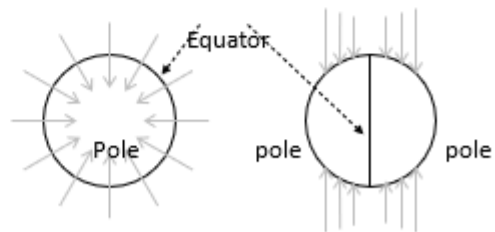

Positron's nuclear field
Figure 12.14

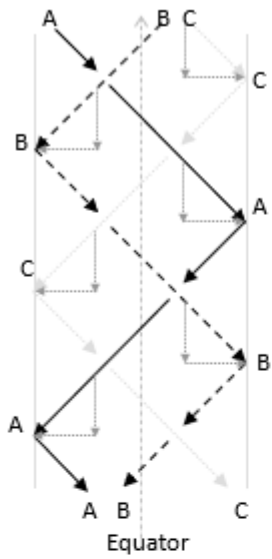

Figure 12.15

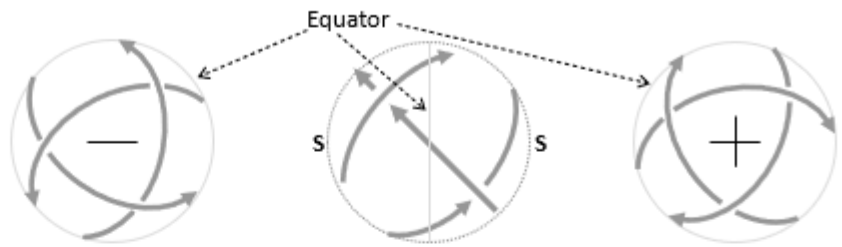
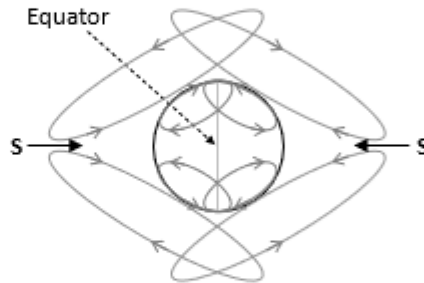
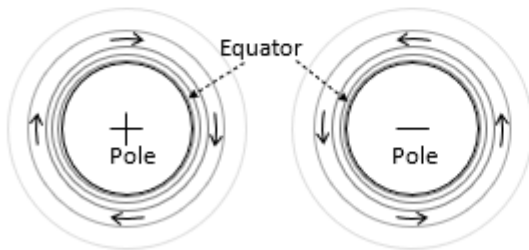

Figure 12.16



Electron's magnetic field
Figure 12.17



Electron's electric field
Figure 12.18

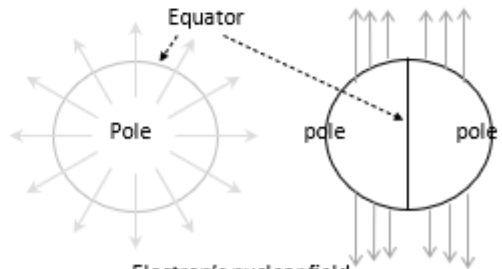

Electron's nuclear field
Figure 12.19

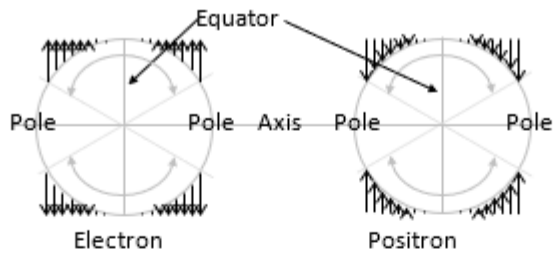

Figure 12.20

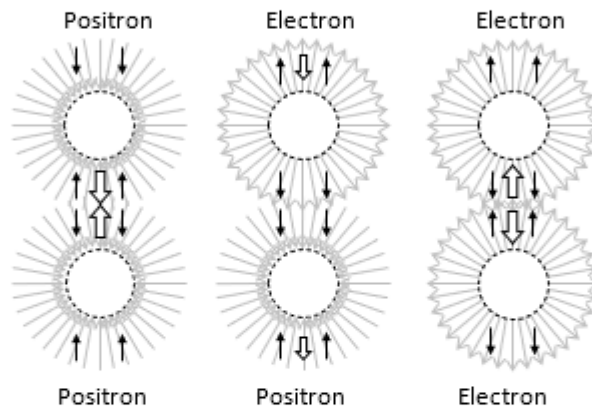

Figure 12.21

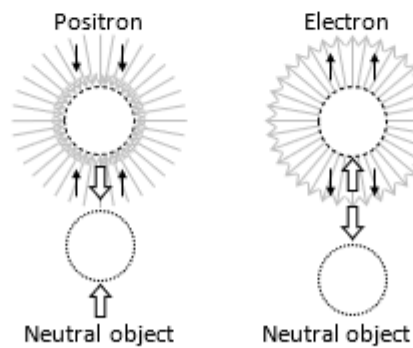

Figure 12.22

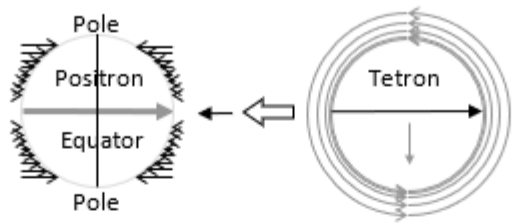

Figure 12.23

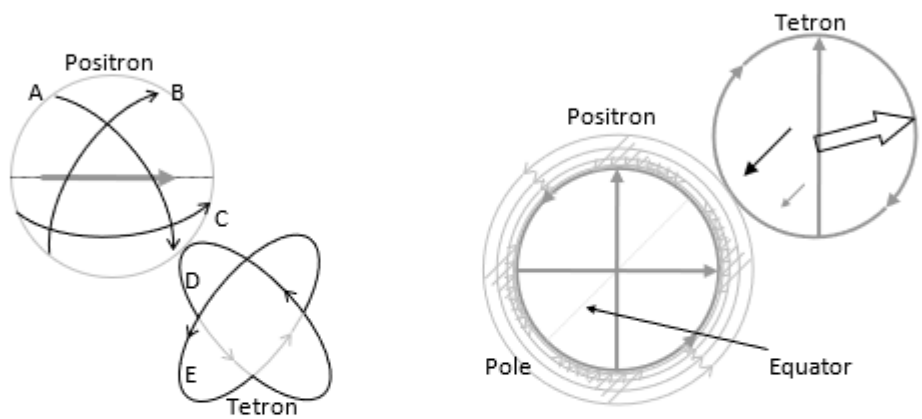

Figure 12.25

Figure 12.24

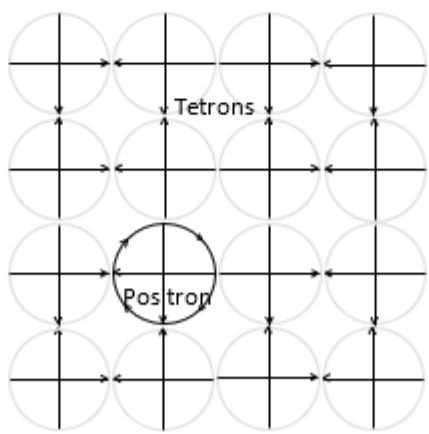

Figure 12.26

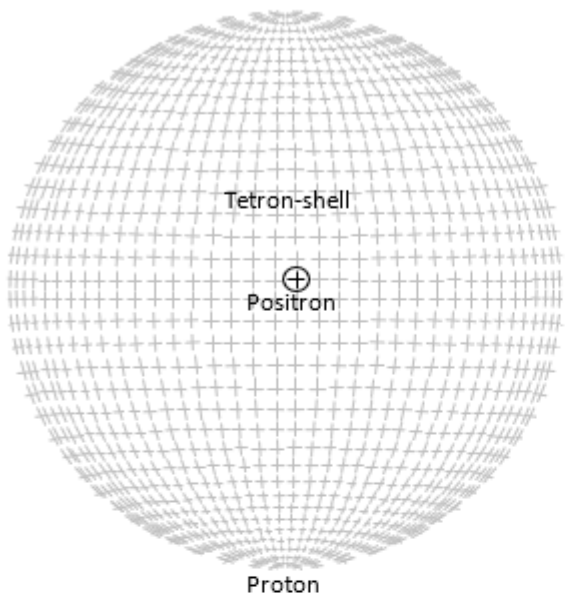

Figure 12.27

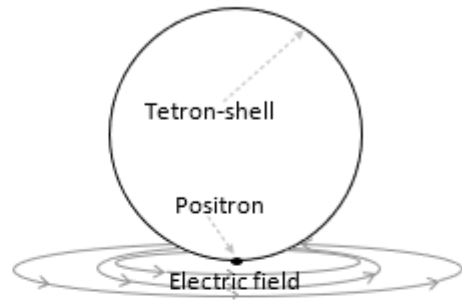

Figure 12.28

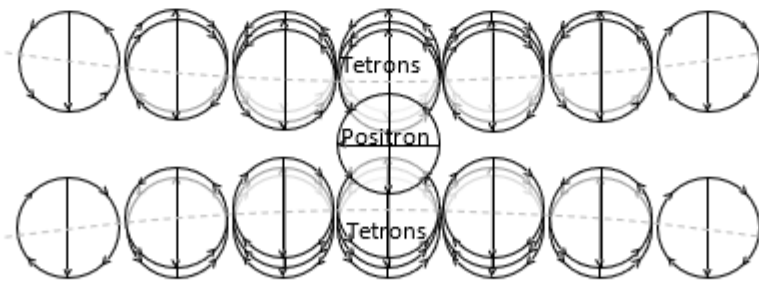

Figure 12.29

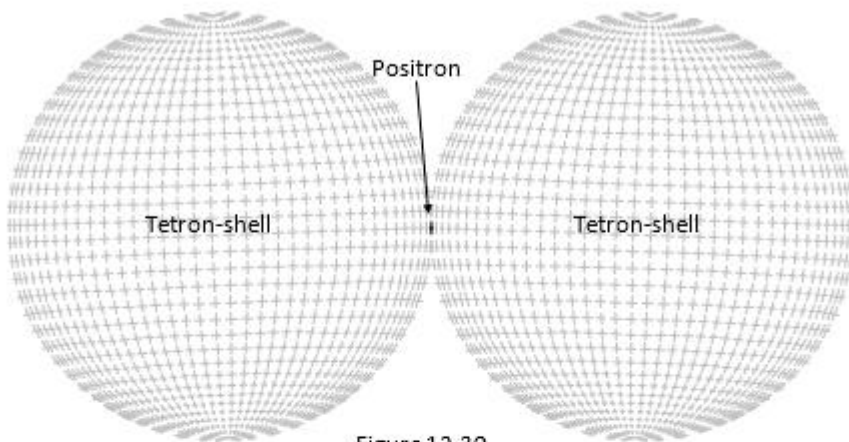

Figure 12.30

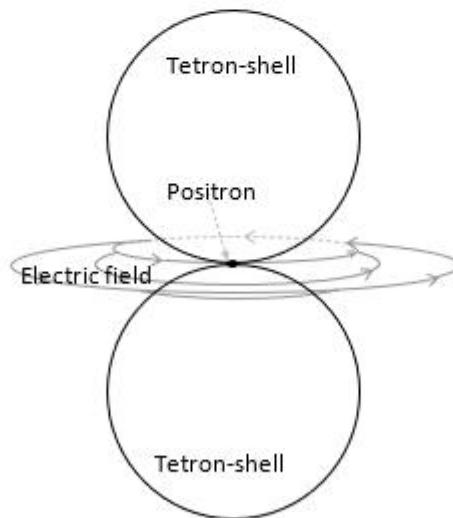

Figure 12.31

ATOM

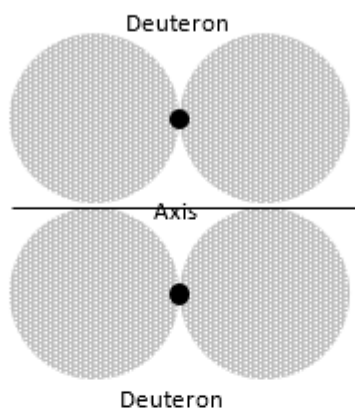
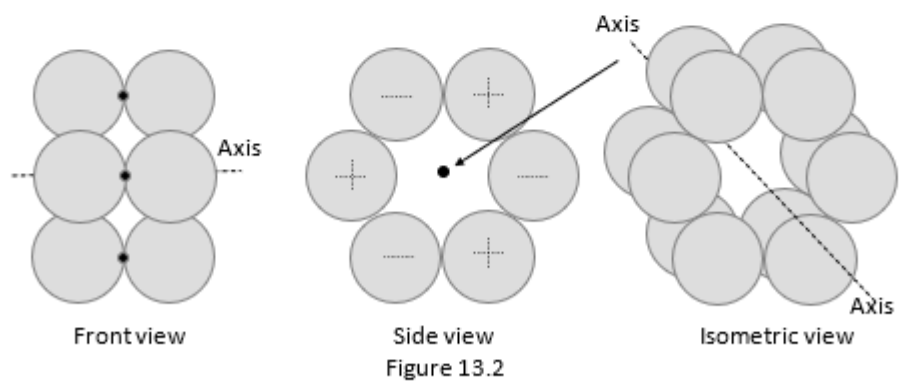

Figure 13.1



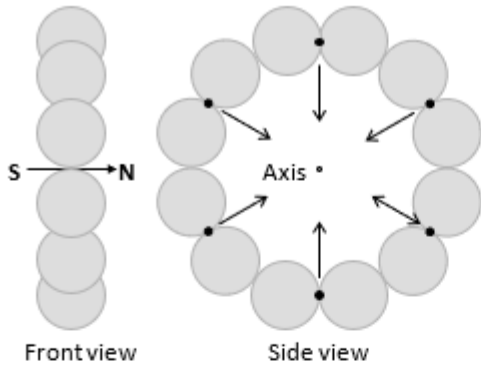

Figure 13.3

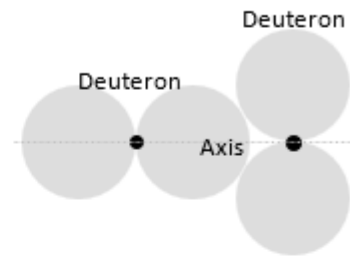

Figure 13.4

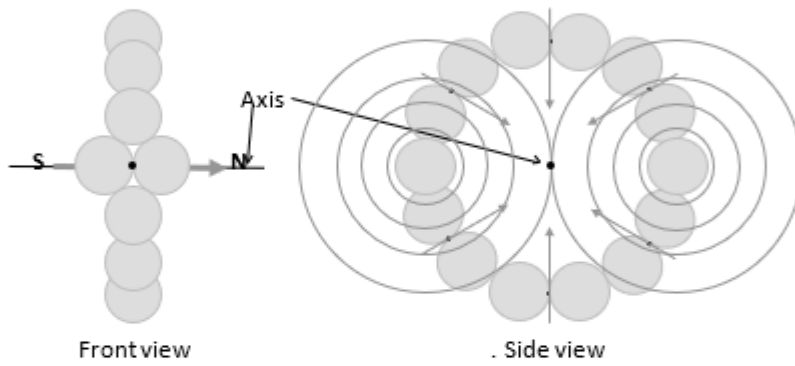

Figure 13.5

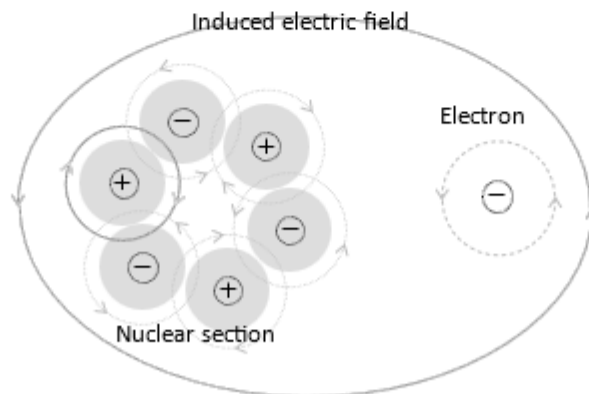

Figure 13.6

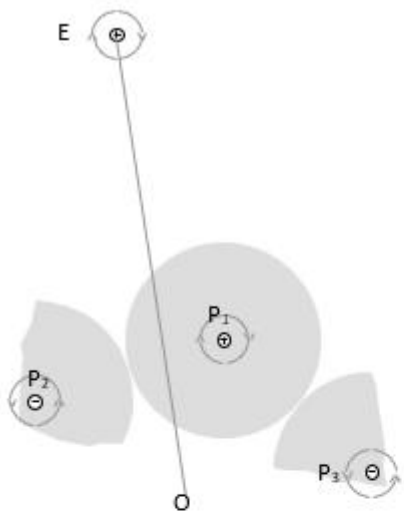

Figure 13.7

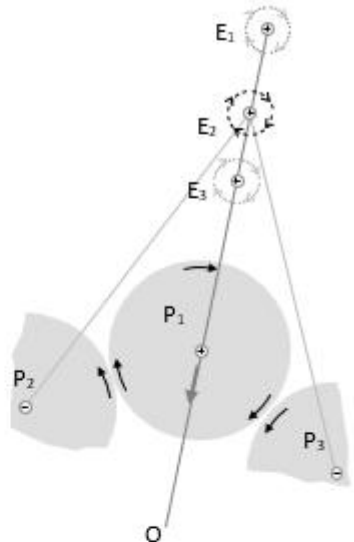

Figure 13.8

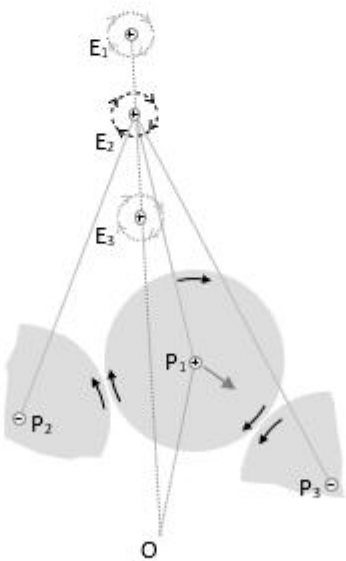

Figure 13.9

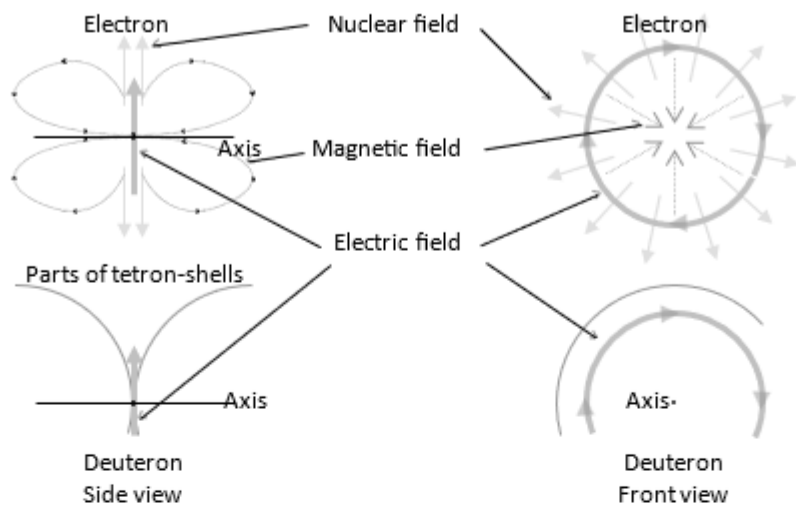

Figure 13.10

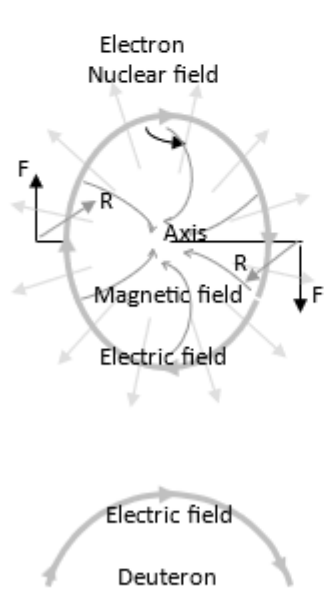

Figure 13.11

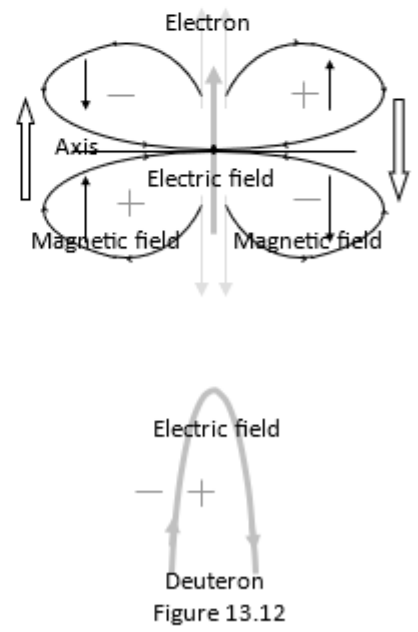

Figure 13.12

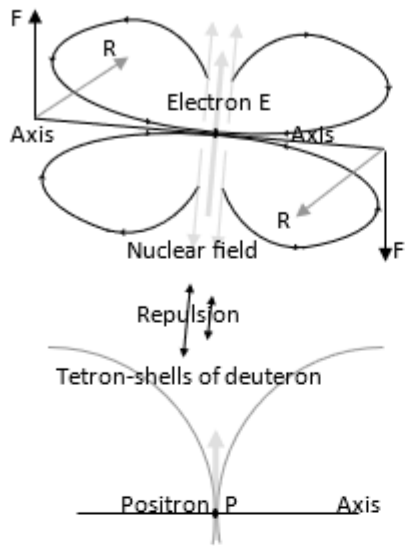

Figure 13.13

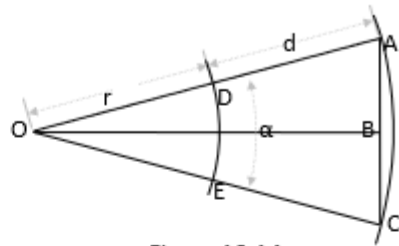

Figure 13.14

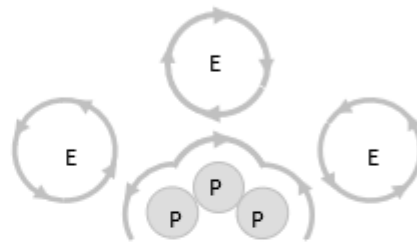

Figure 13.15

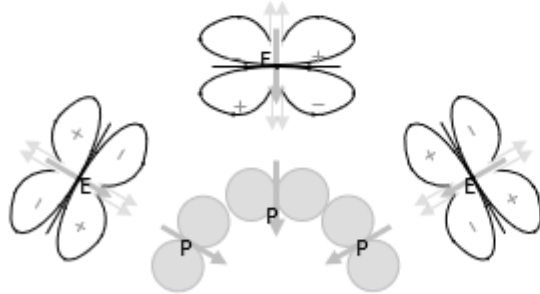

Figure 13.16

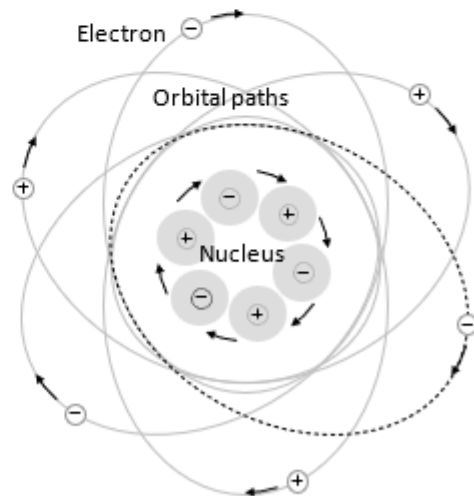

Figure 13.17

ELECTRICITY

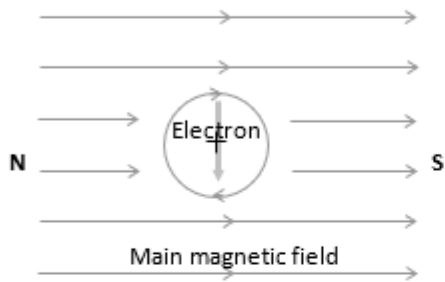

Figure 14.1

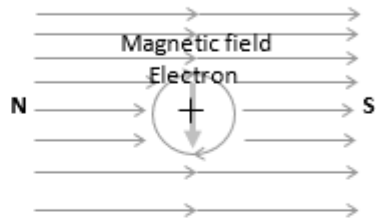

Figure 14.2

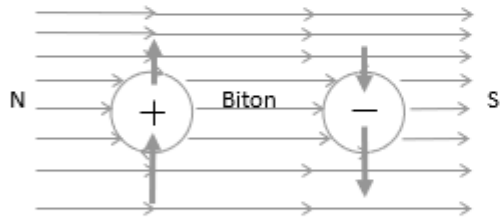

Figure 14.3

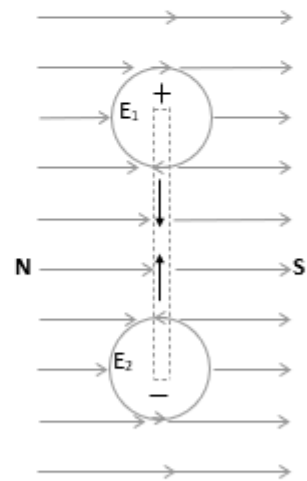

Figure 14.4

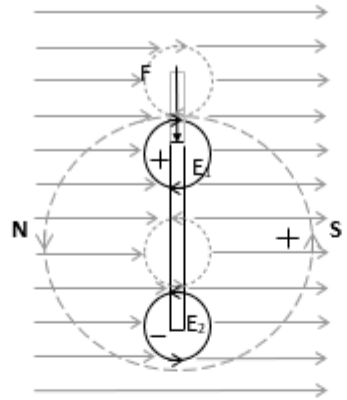

Figure 14.5

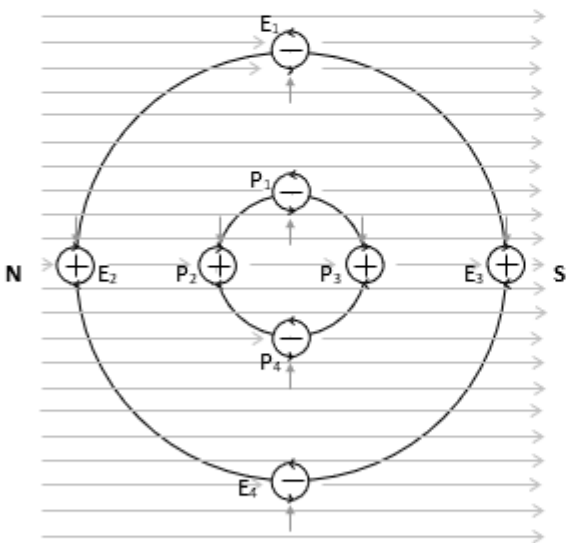

Figure 14.6

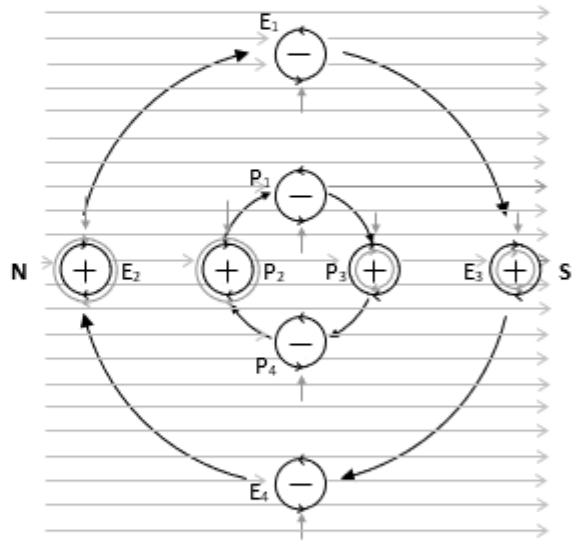

Figure 14.7

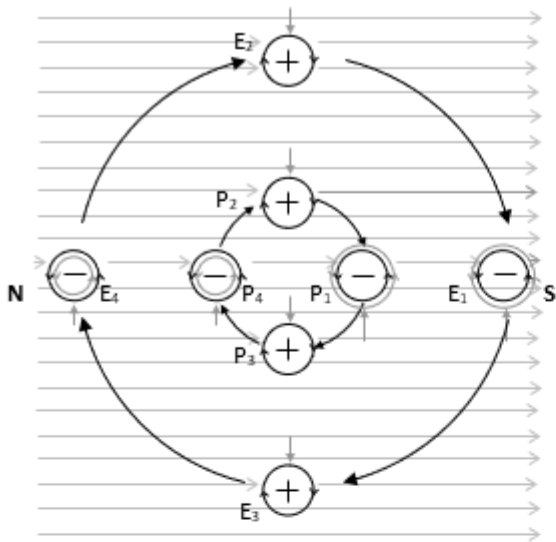

Figure 14.8

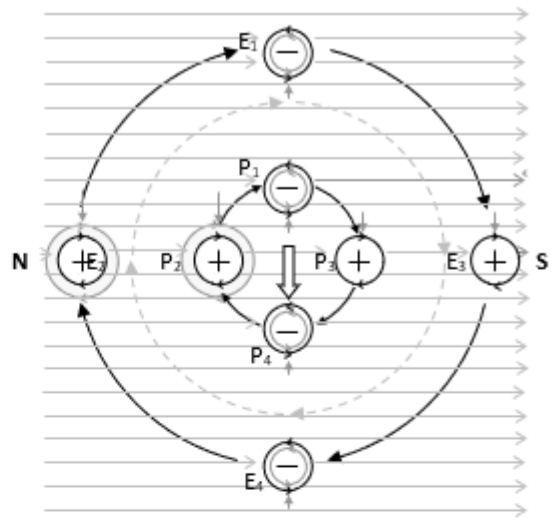

Figure 14.9

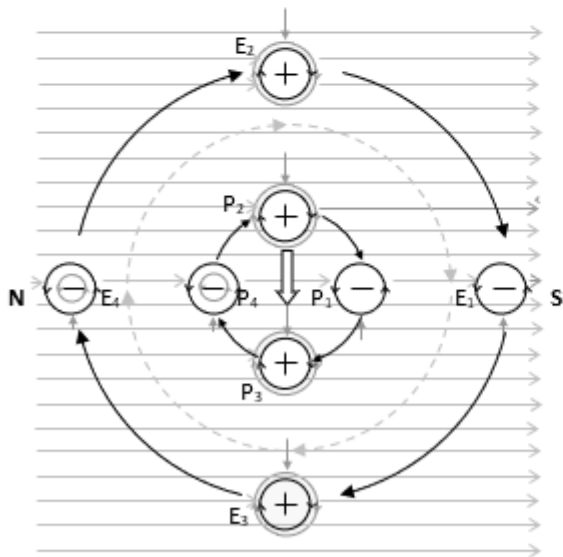

Figure 14.10

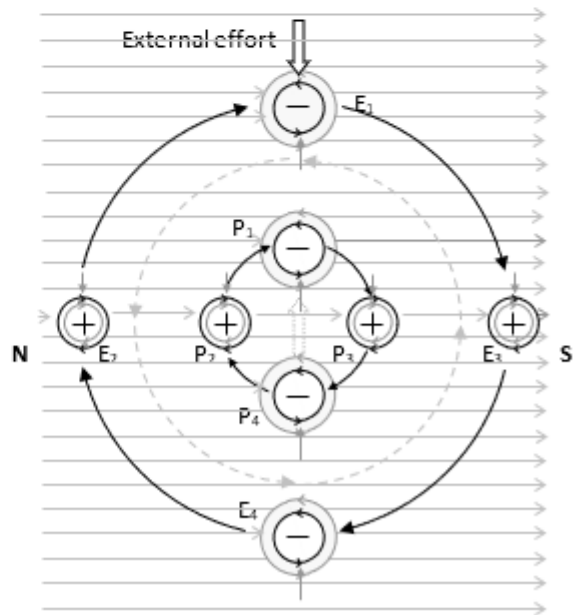

Figure 14.11

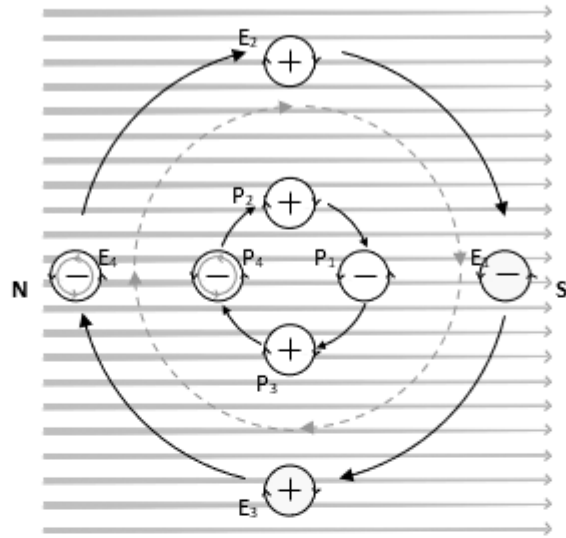

Figure 14.14

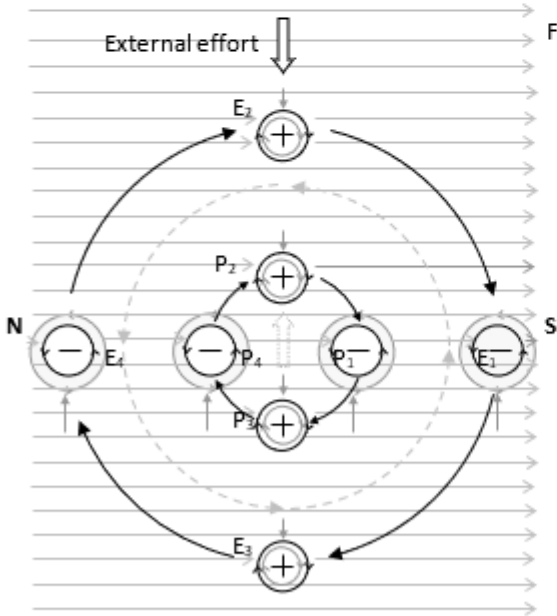

Figure 14.12

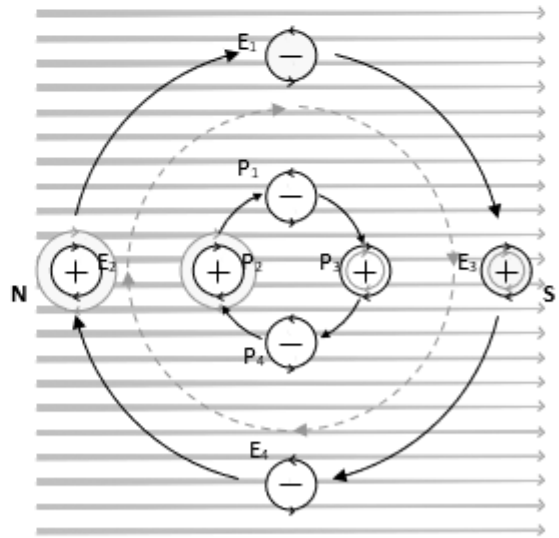

Figure 14.13

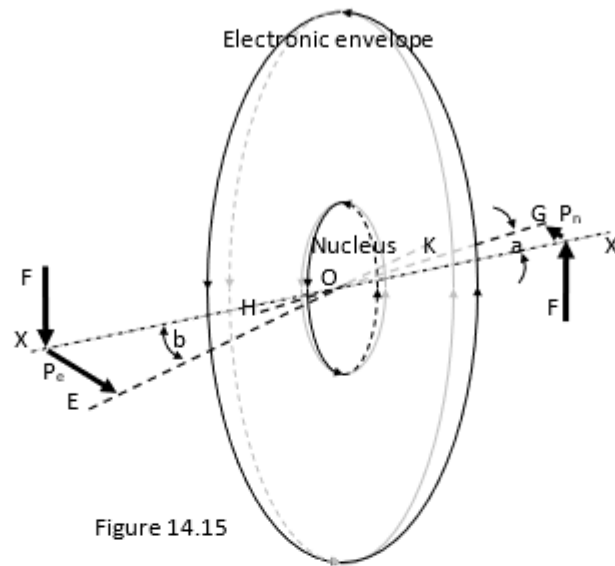

Figure 14.15

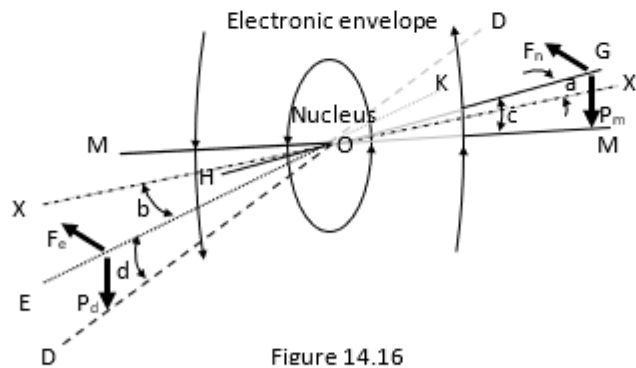

Figure 14.16

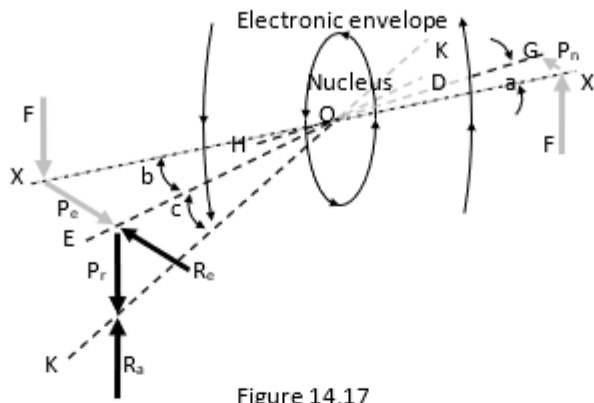

Figure 14.17

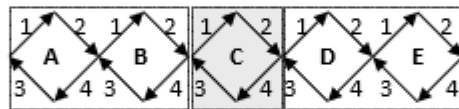

Figure 14.18

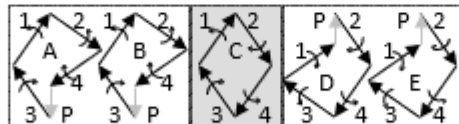

Figure 14.19

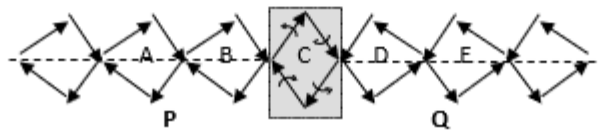

Figure 14.20

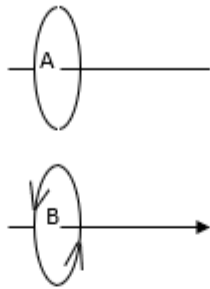

Figure 14.21

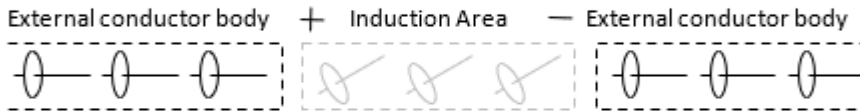

Figure 14.22

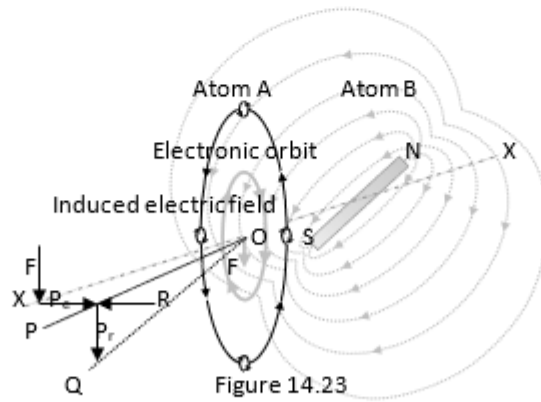

Figure 14.23

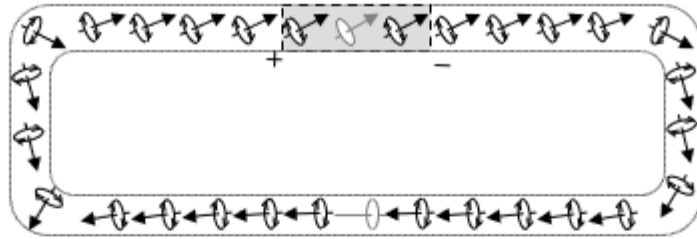

Figure 14.24

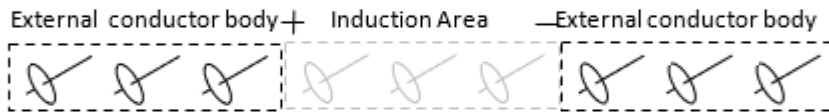

Figure 14.25

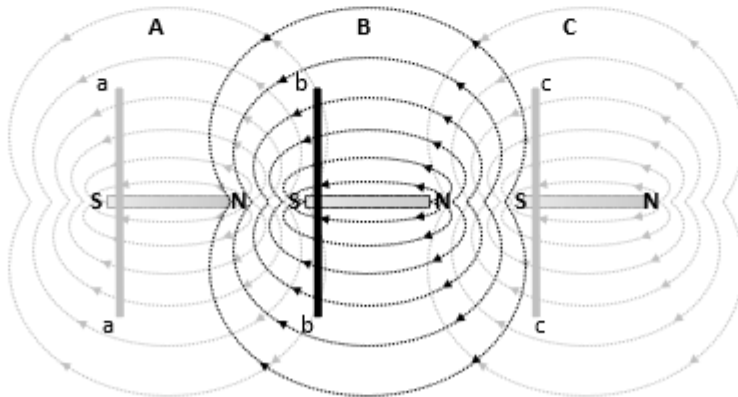

Figure 14.26

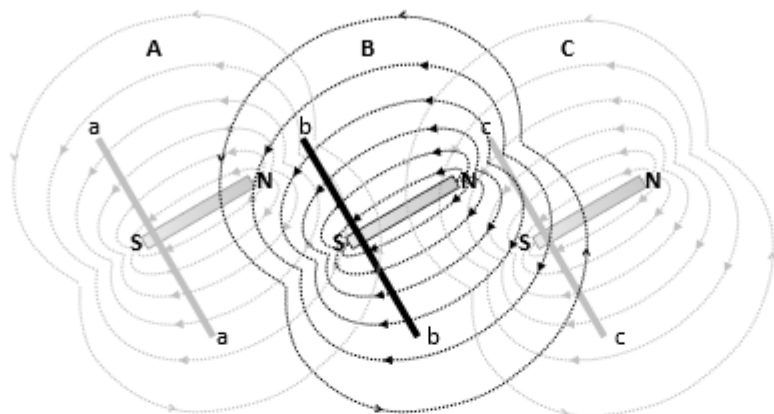

Figure 14.27

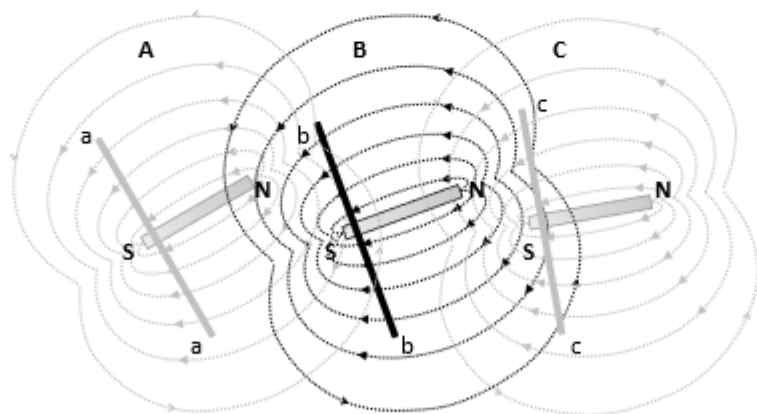

Figure 14.28

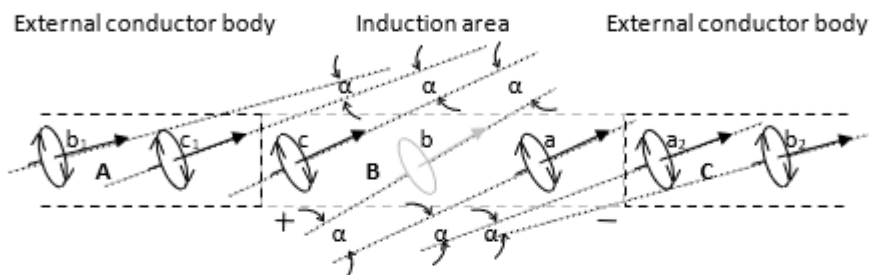

Figure 14.29

CAPACITANCE

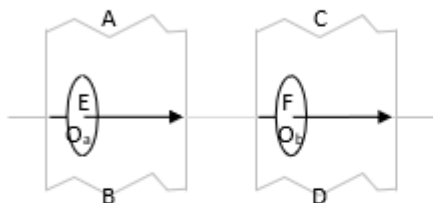

Figure 15.1

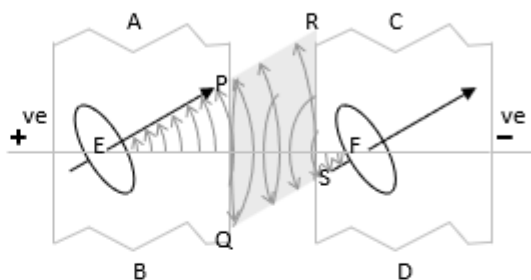

Figure 15.2

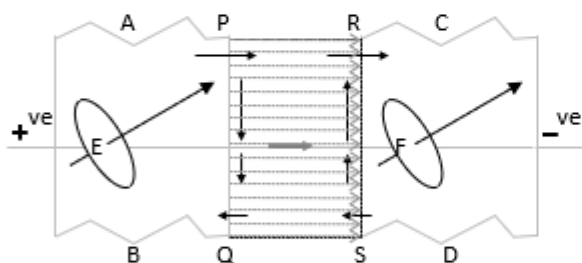

Figure 15.3

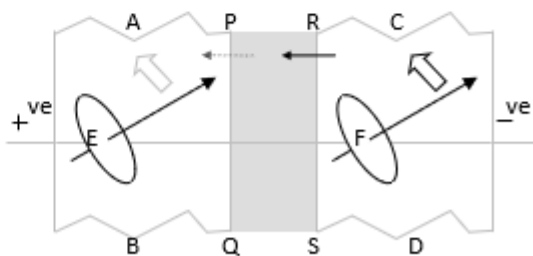

Figure 15.4

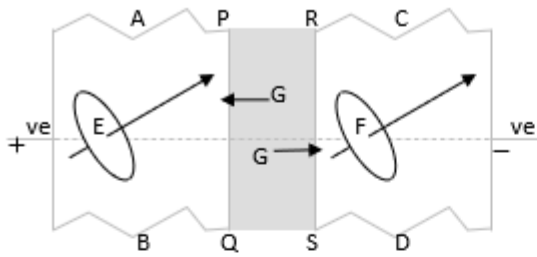

Figure 15.5

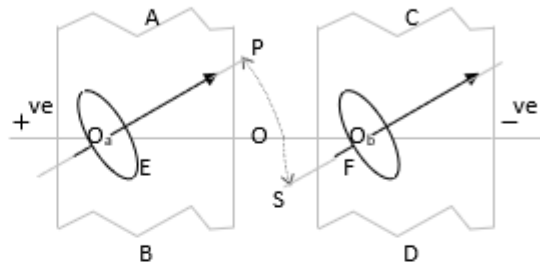

Figure 15.6

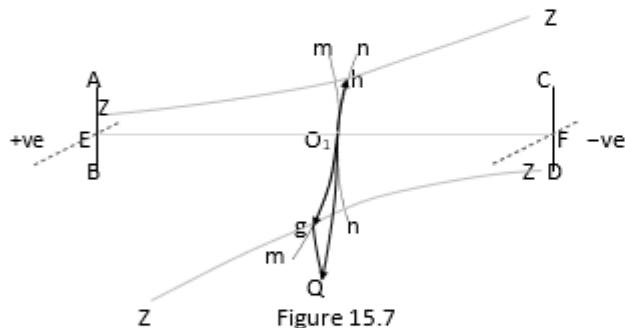

Figure 15.7

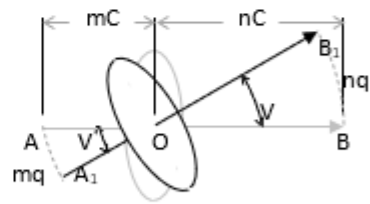

Figure 15.8

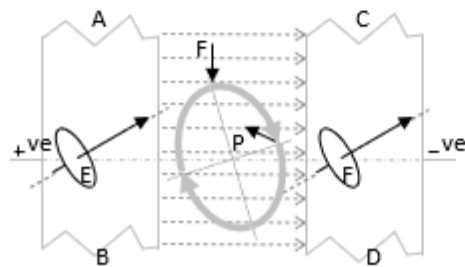

Figure 15.9

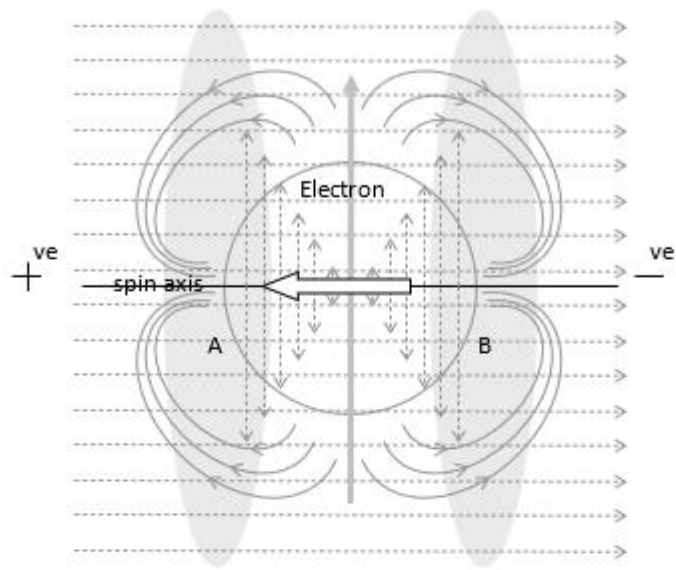

Figure 15.10

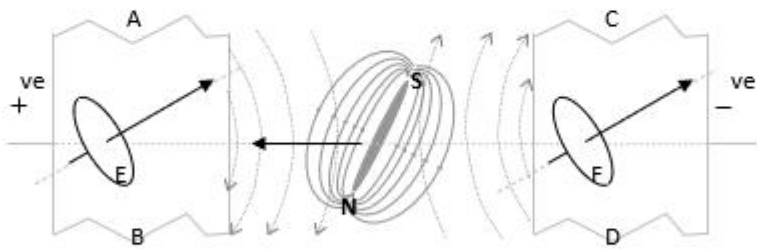
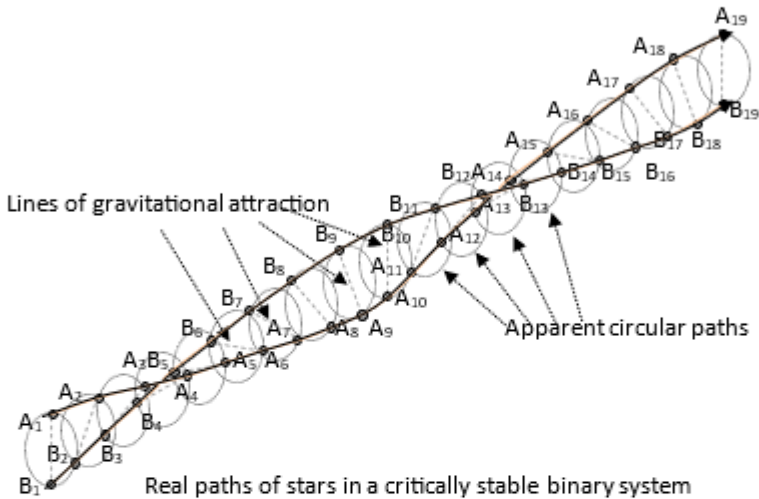

Figure 15.11

COSMOLOGY



Real paths of stars in a critically stable binary system
Figure 16.1.

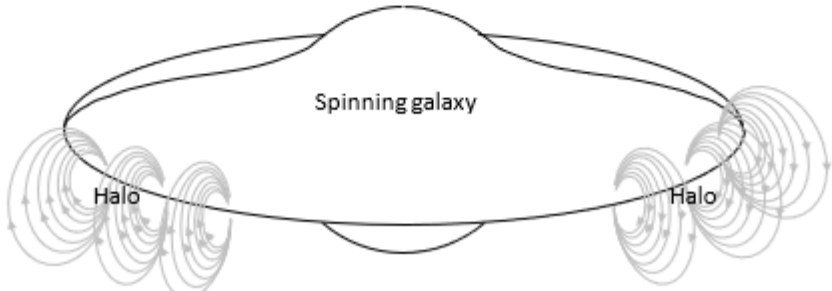

Figure 16.2



Figure 16.3

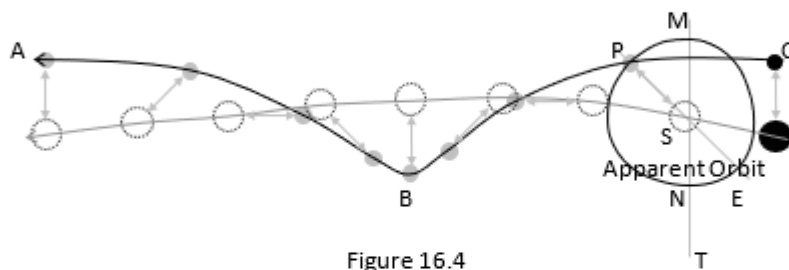

Figure 16.4

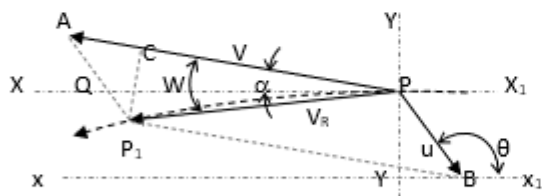

Figure 16.5

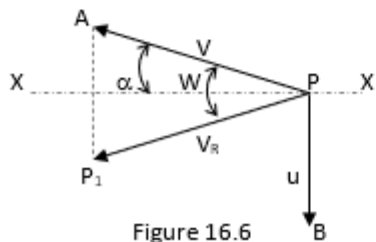
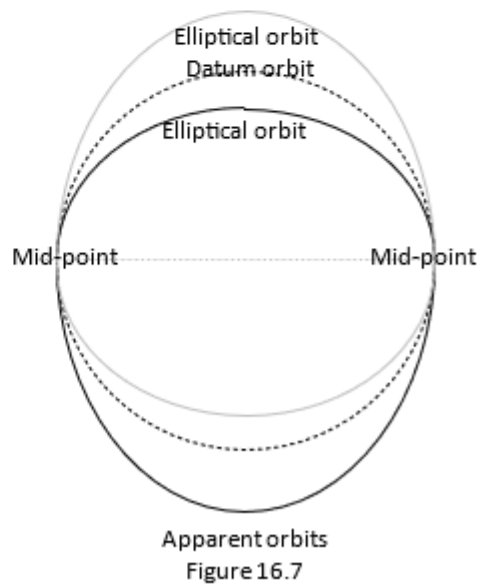

Figure 16.6



Apparent orbits
Figure 16.7

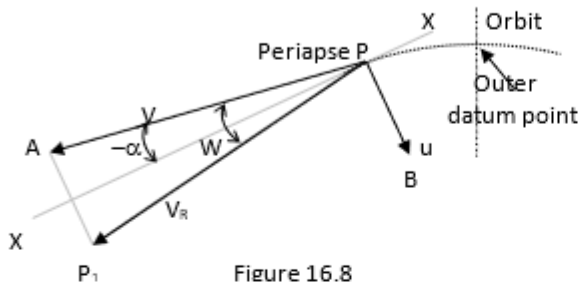

Figure 16.8

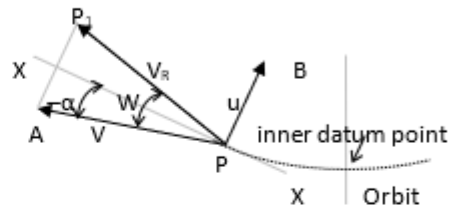

Figure 16.9

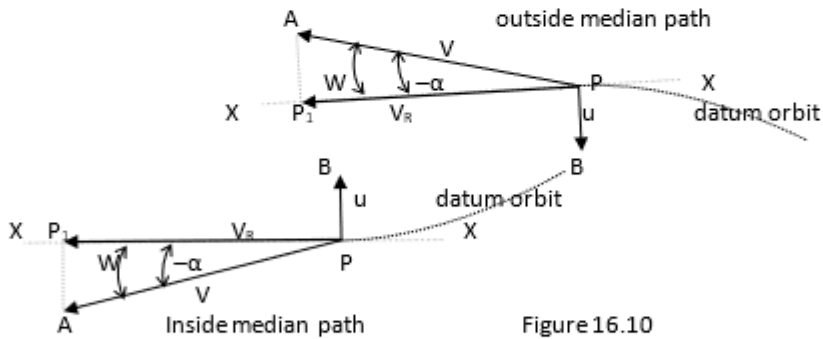

Figure 16.10

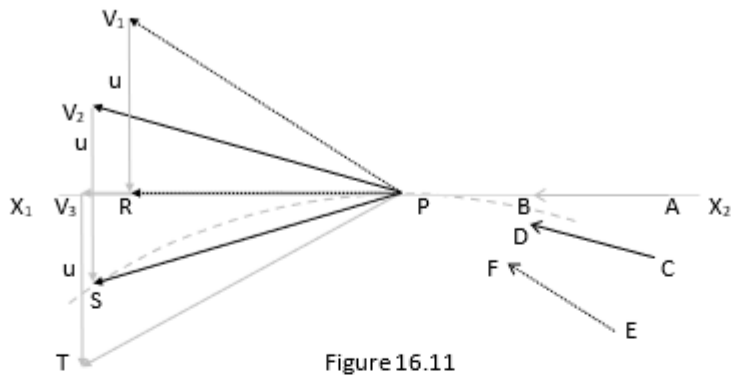

Figure 16.11

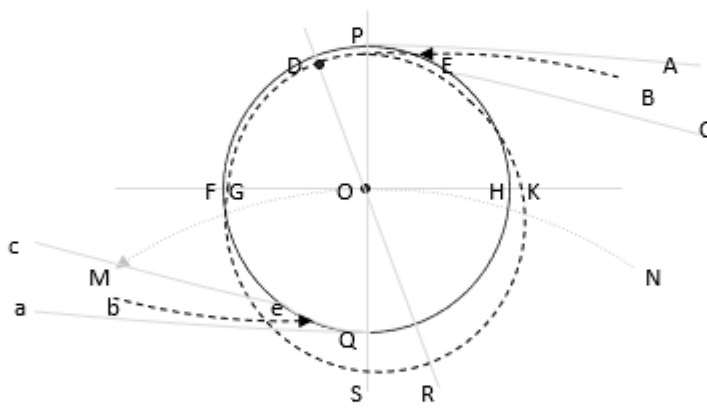

Figure 16.12

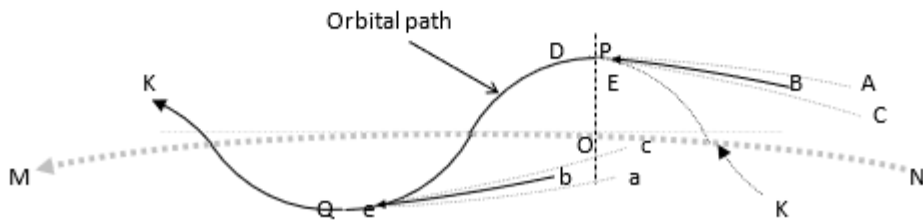
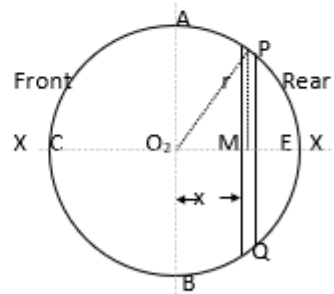
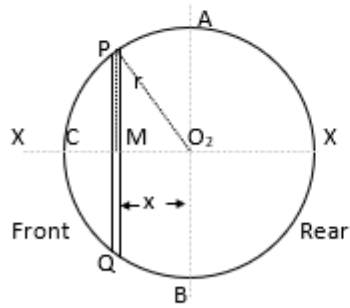
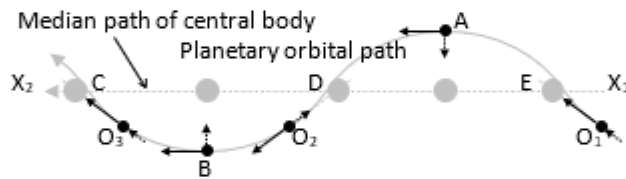
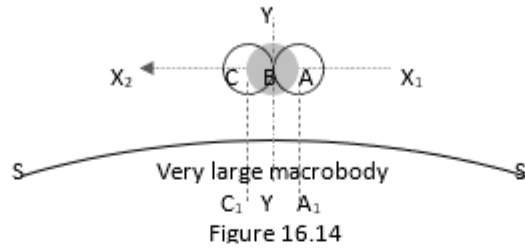
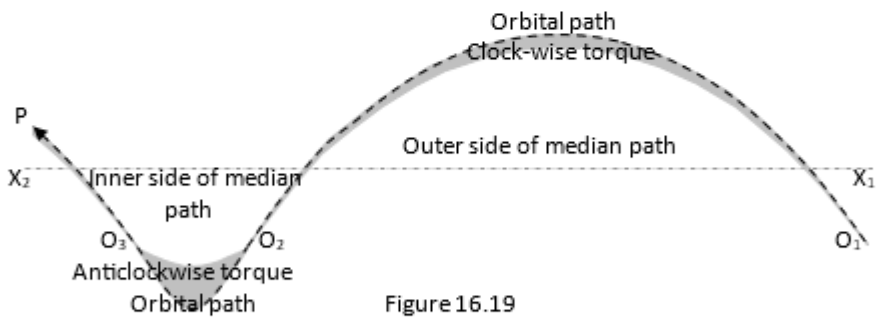
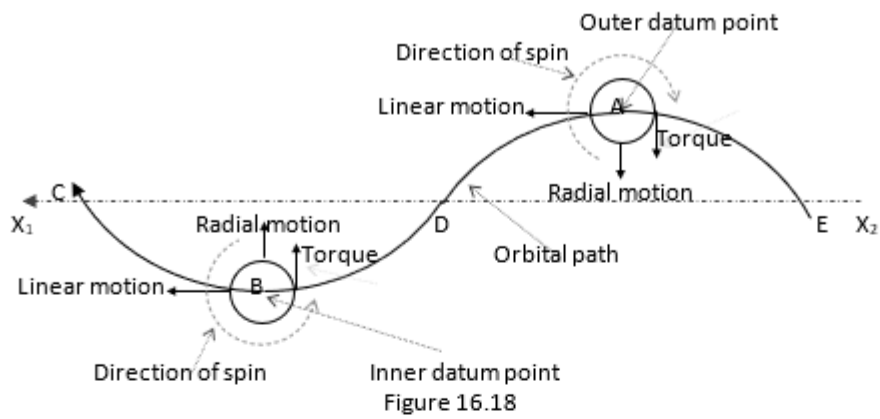

Figure 16.13





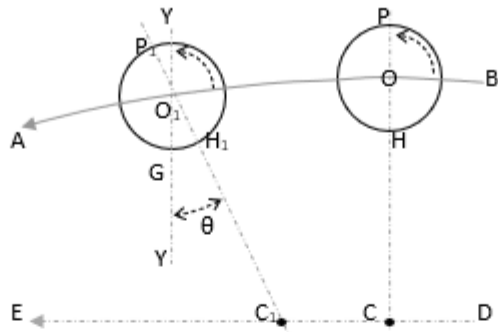

Figure 16.20

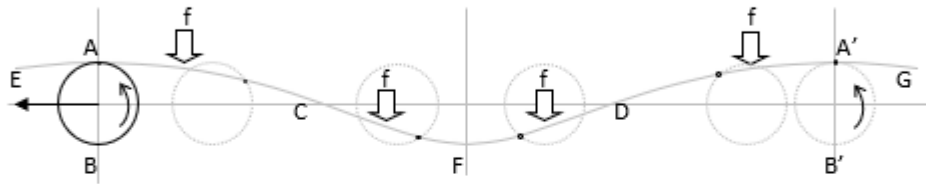

Figure 16.21

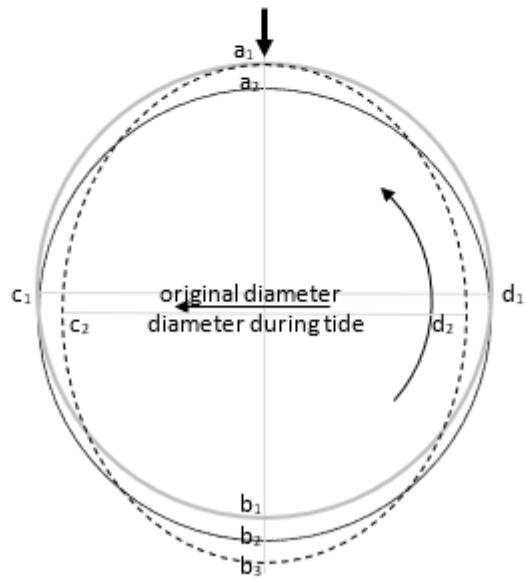

Figure 16.22

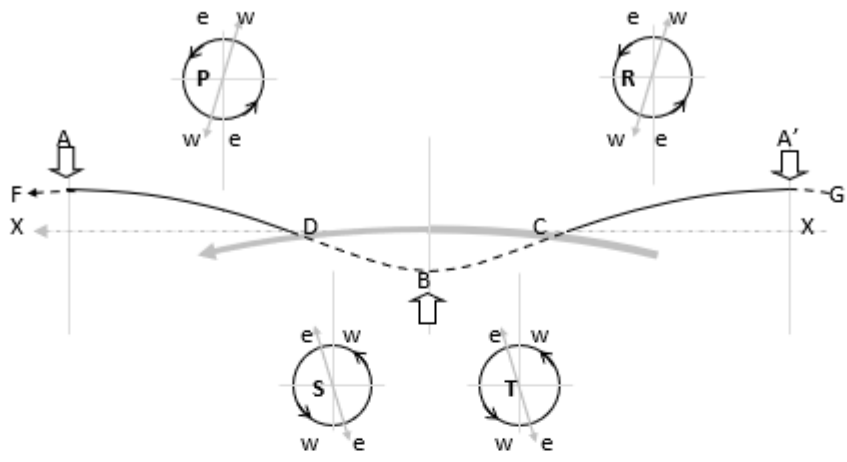

Figure 16.26

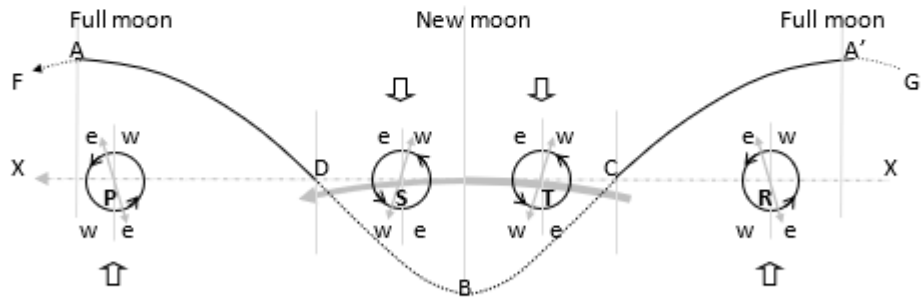

Figure 16.27

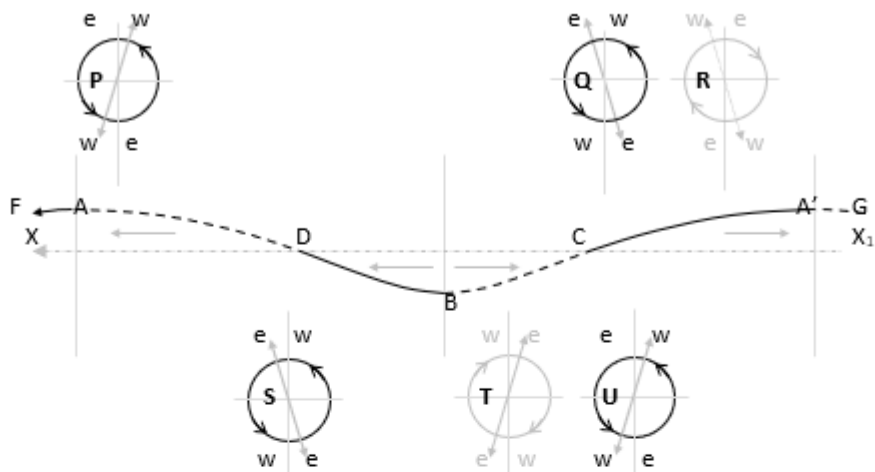

Figure 16.28

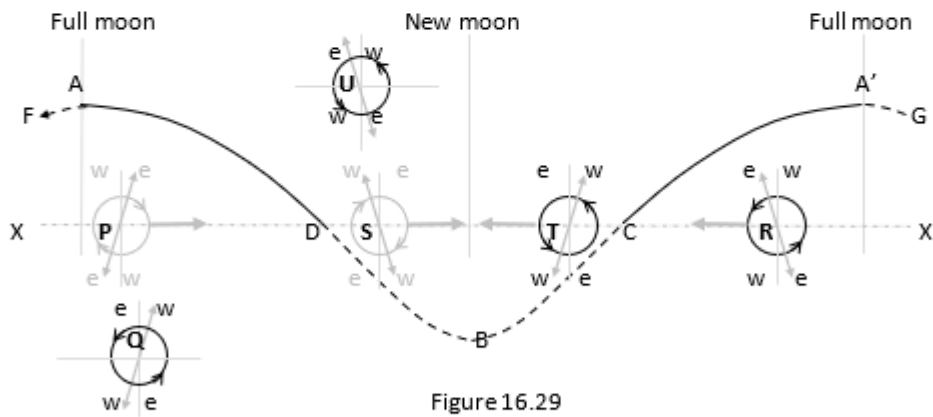

Figure 16.29

GENERAL

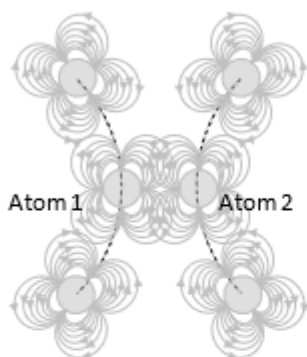

Figure 17.1

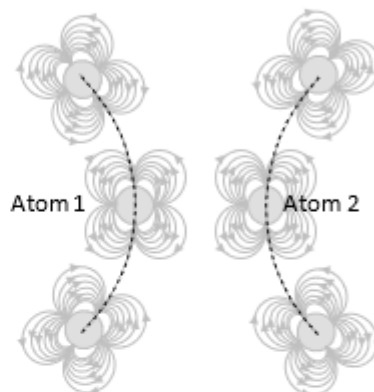

Figure 17.2

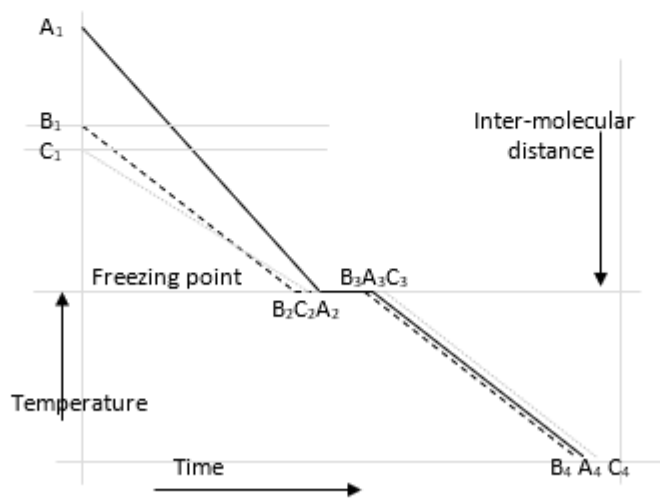

Figure 17.3

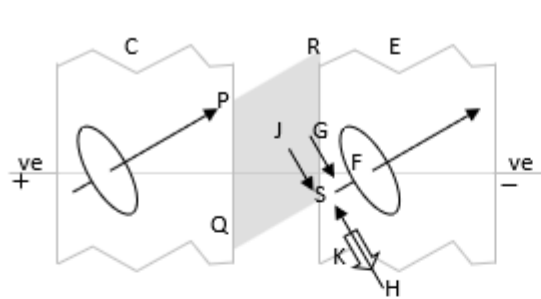

Figure 17.4

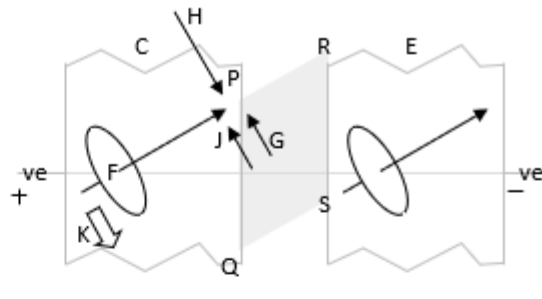

Figure 17.5

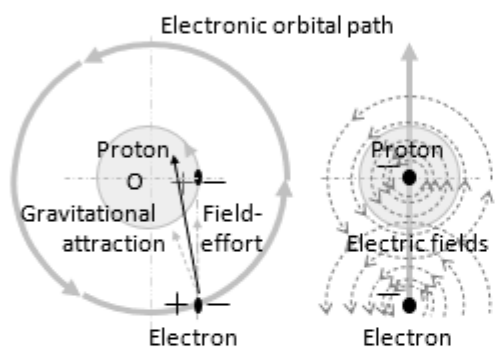

Figure 17.6

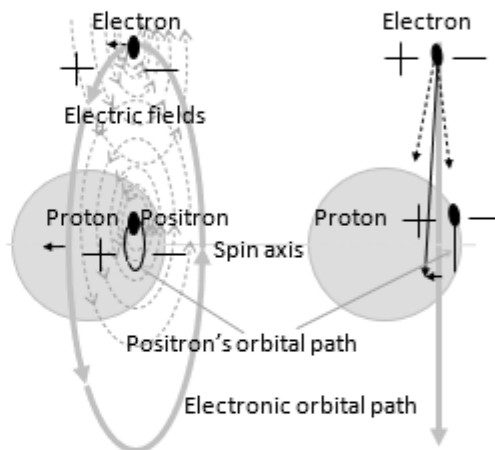

Figure 17.7

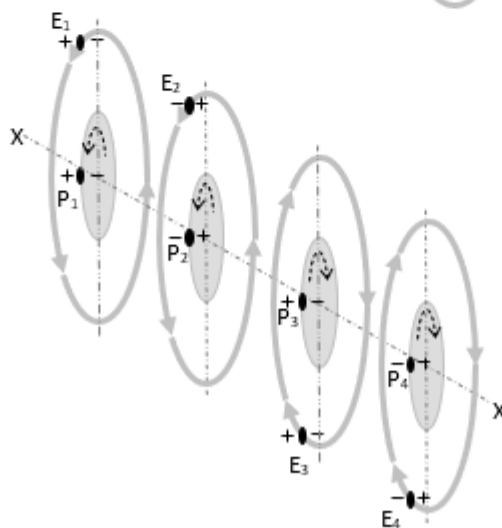

Figure 17.8

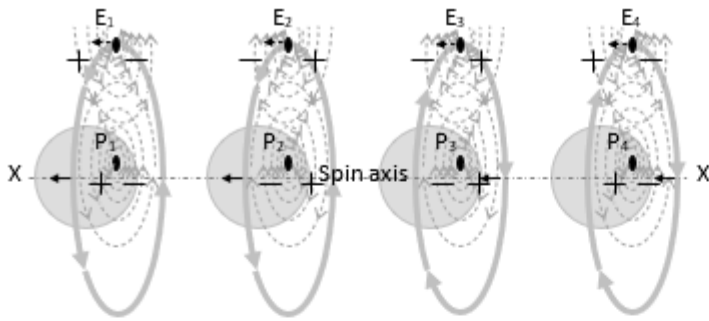

Figure 17.9

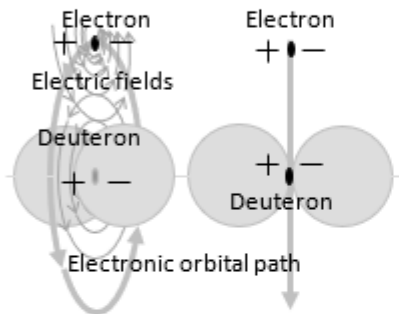

Figure 17.10

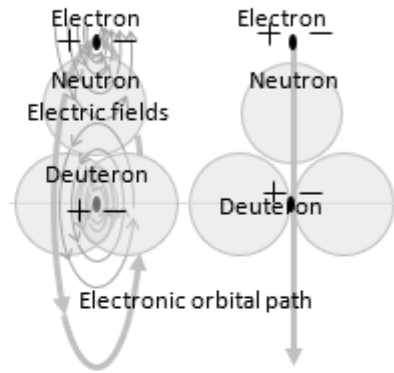

Figure 17.11

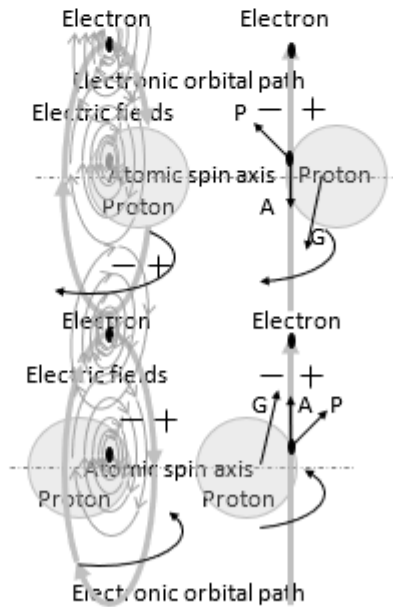

Figure 17.12

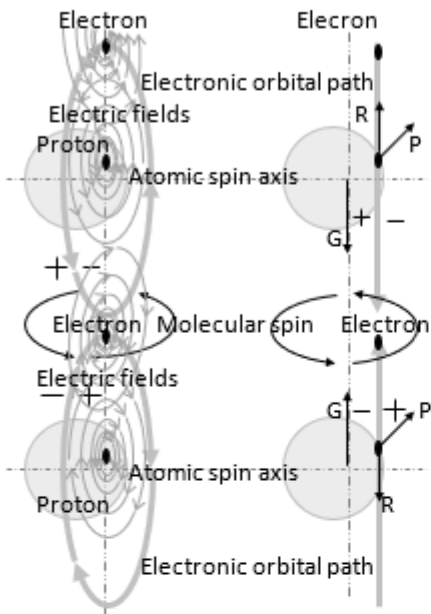

Figure 17.13

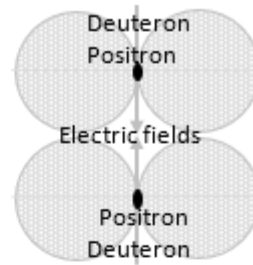

Figure 17.14

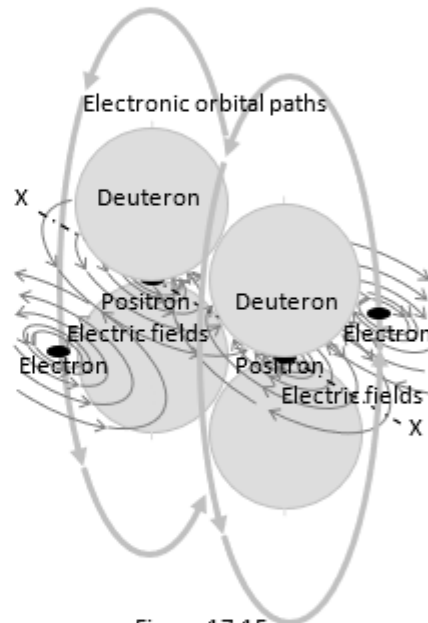

Figure 17.15

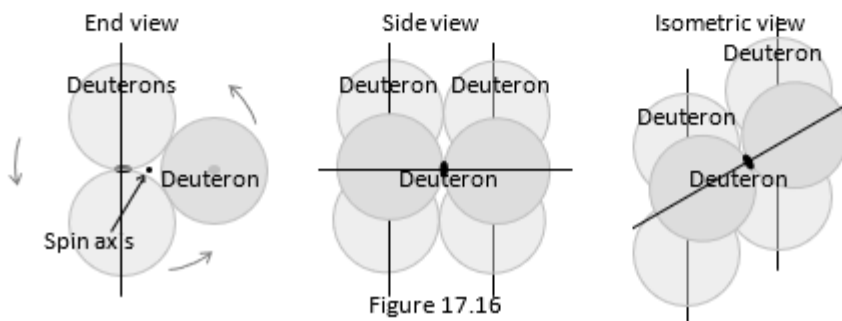

Figure 17.16

Figure 17.17 -- Deleted.

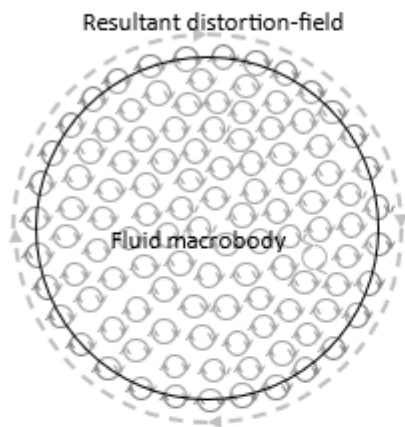

Figure 17.18

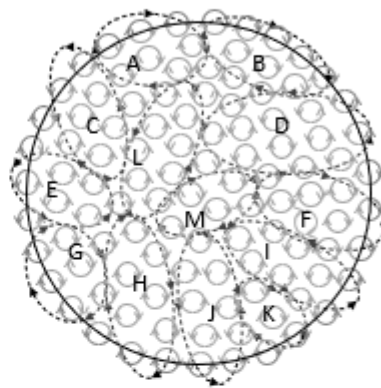

Figure 17.19

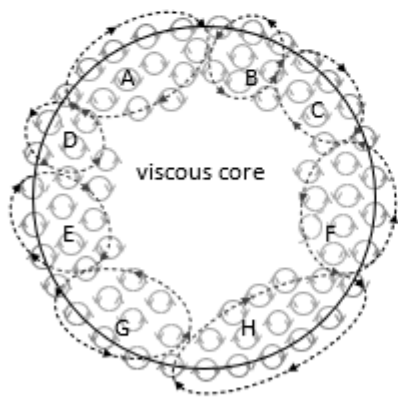

Figure 17.20

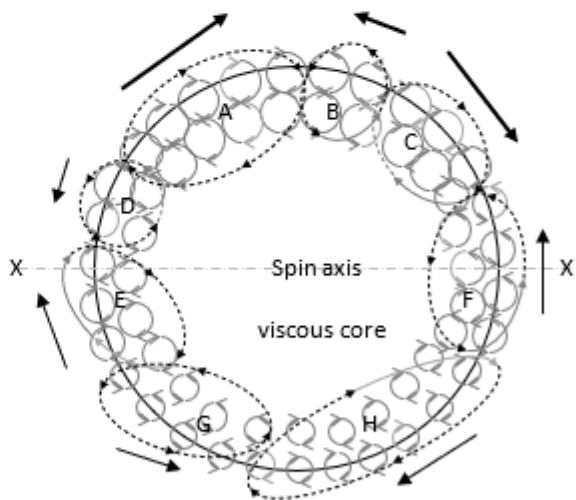
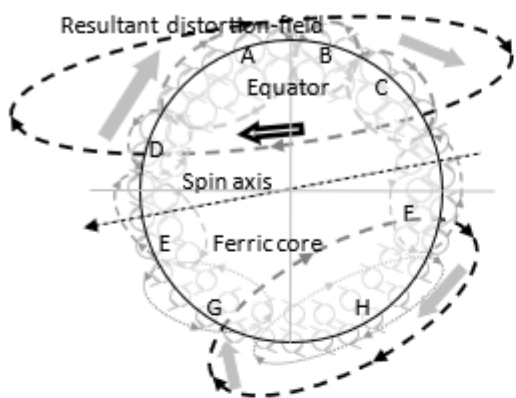

Figure 17.21



Resultant distortion-field
Figure 17.22

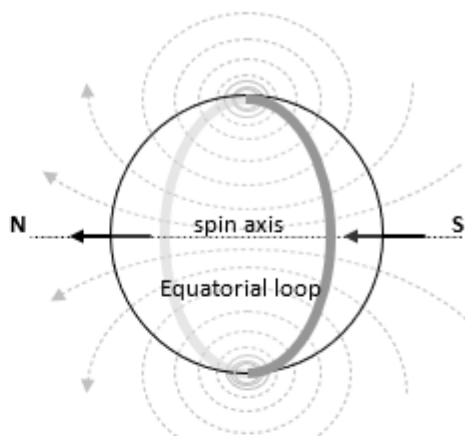

Figure 17.23

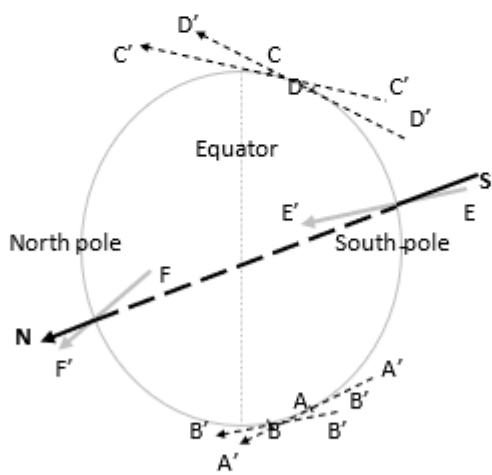

Figure 17.24